

Part No. A1001013

Automotive ISM / Wi-Fi / BT On / Off Ground Antenna

2400 - 2485 MHz

Supports: Wi-Fi applications, Bluetooth, WLAN, ISM



Automotive FR4 ISM / Wi-Fi / Bluetooth Antenna

2400 – 2485 MHz

KEY BENEFITS

Stay-in-Tune

IMD antenna technology provides superior RF field containment, resulting in less interaction with surrounding components.

Quicker Time-to-Market

By optimizing antenna size, performance and emissions, customer and regulatory specifications are more easily met.

Reliability

Products are the latest RoHS version compliant.

APPLICATIONS

- Automotive
- Infotainment
- Embedded design
- Telematics
- Tracking
- Smart Grid
- OBD-II
- Agriculture, Industrial Applications

KYOCERA AVX A-Series automotive antennas deliver on the key needs of device designers for higher functionality.

KYOCERA AVX has completed rigorous testing to qualify the A-series antennas for automotive applications. Although the AEC-Q200 standard does not include antenna products, all testing has been done following applicable AEC-Q200 requirements and procedures as closely as possible. Customers must provide additional quality requirements, if any, to drive additional compliance testing.

Electrical Specifications

Typical Characteristics, on 50 x 70 mm PCB

Frequency	2400 – 2485 MHz	
Mounting	Off Ground	On Ground (Over Metal)
VSWR Match	1.5:1 max	1.8:1 max
Average Efficiency	76%	48%
Peak Gain	2.6 dBi	0.7 dBi
Feed Point Impedance	50 ohms unbalanced	
Polarization	Linear	
Power Handling	0.5 Watt CW	

Mechanical Specifications & Ordering Part Number

Ordering Part Number	A1001013
Size (mm)	15.0 x 3.2 x 3.3
Mounting	SMT (P&P)
Weight (grams)	0.2
Packaging	Tape & Reel
Demo Board	1001013-02
Temperature Range	-50/+125 °C
Temperature Cycle	IEC 60068-2-14
Temperature Exposure	Mil-STD-202 Method 108
High Temperature & High Humidity	MIL-STD-202
Mechanical Shock	IEC 60068-2-27
Vibration	IEC 60068-2-6
IMDS and PPAP available	

2.4 GHz KYOCERA AVX Automotive Embedded Antenna Specifications.
 KYOCERA AVX produces a wide variety of standard and custom antennas to meet user needs.

Antenna Dimensions

Typical antenna dimensions (mm)

Part Number	A	B	C
A1001013	15.0 ± 0.2	3.2 ± 0.1	3.3 ± 0.3

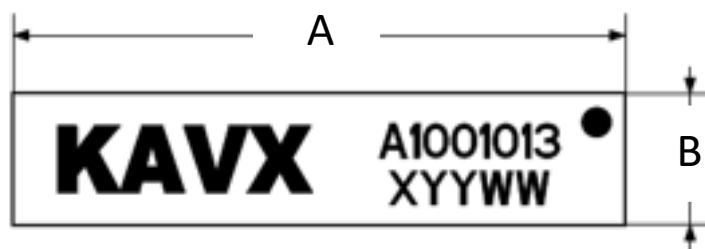

Top View

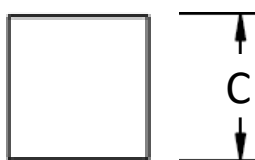

Height

Pin	Description
1	Feed
2	Dummy Pad
3	Dummy Pad

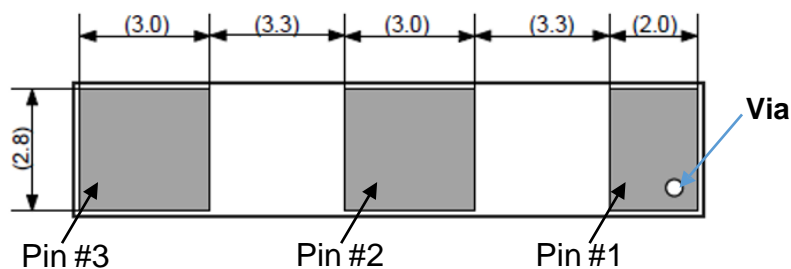

Bottom View

2.4 GHz KYOCERA AVX Automotive Embedded Antenna Specifications.
 KYOCERA AVX produces a wide variety of standard and custom antennas to meet user needs.

VSWR and Efficiency Plots (Off-Ground)

Typical performance on 50 x 70 mm PCB

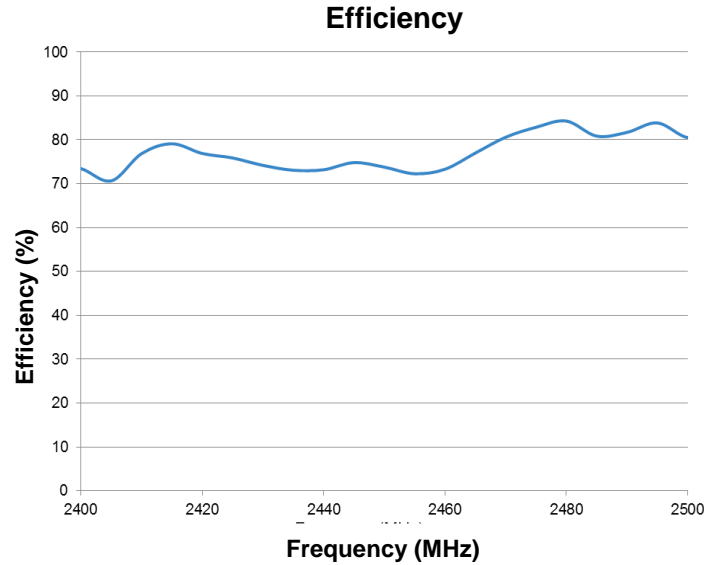
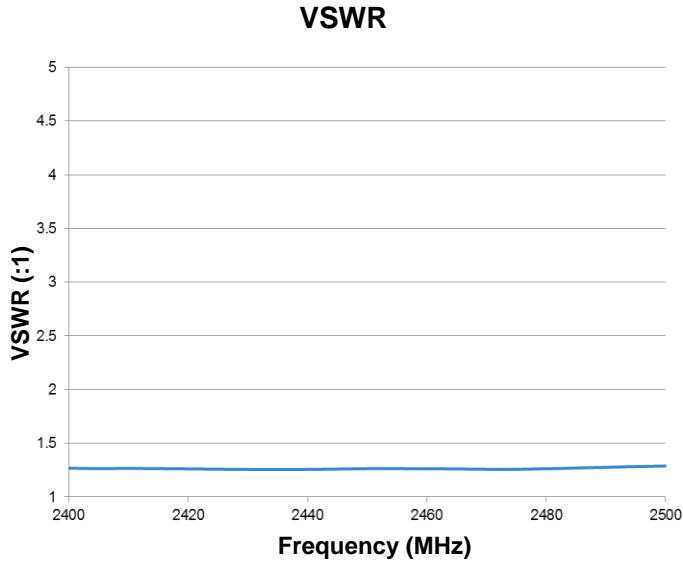

Antenna Radiation Patterns (Off-Ground)

Typical performance on 50 x 70 mm PCB

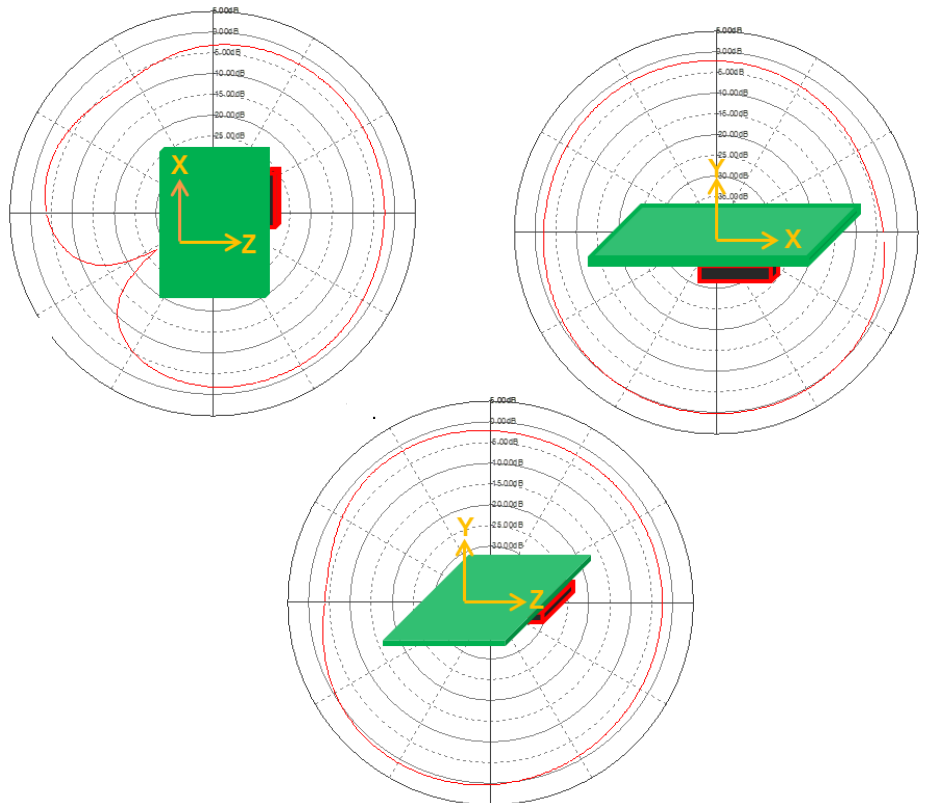
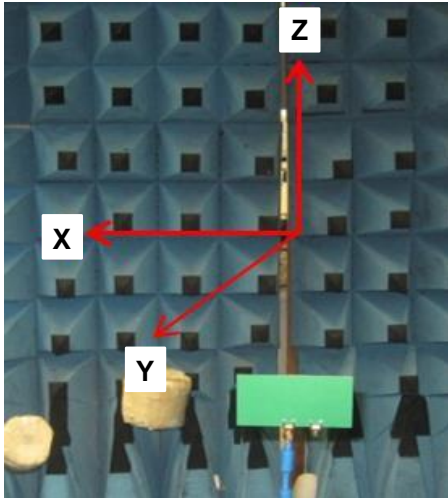

2.4 GHz KYOCERA AVX Automotive Embedded Antenna Specifications.
 KYOCERA AVX produces a wide variety of standard and custom antennas to meet user needs.

Antenna Layout (Off-Ground)

Typical layout dimensions (mm)

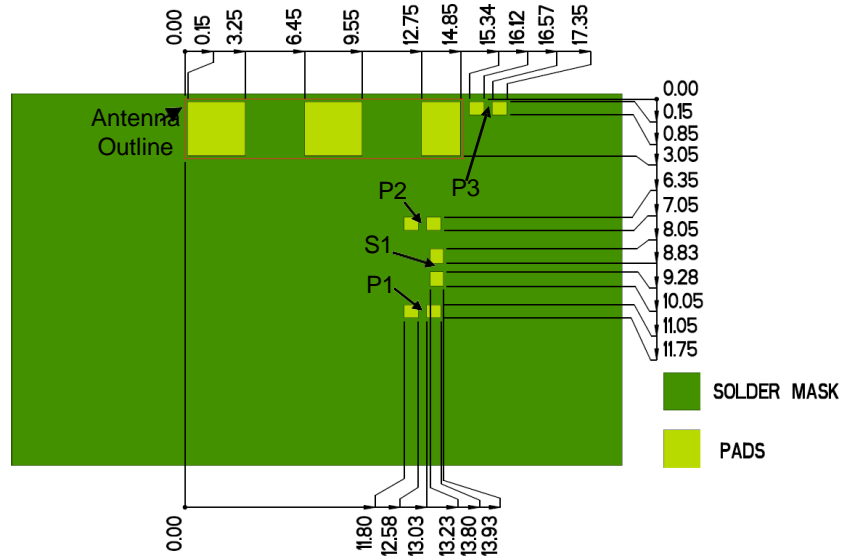
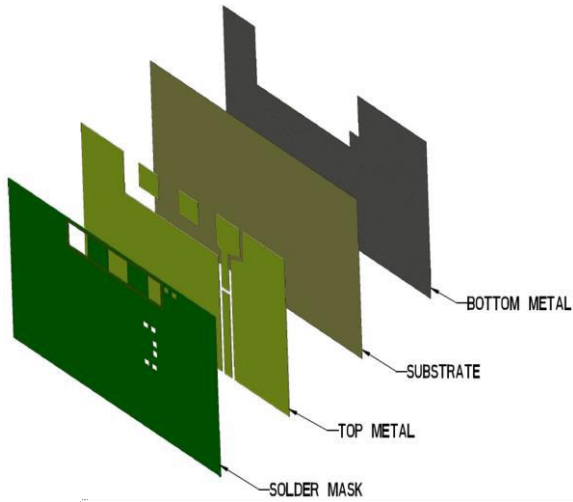

* VIAS: Diam. 0.2mm, (no vias on transmission lines).
 Via holes must be covered by solder mask

Pin Descriptions

Pin#	Description
1	Feed
2	Dummy Pad
3	Dummy Pad

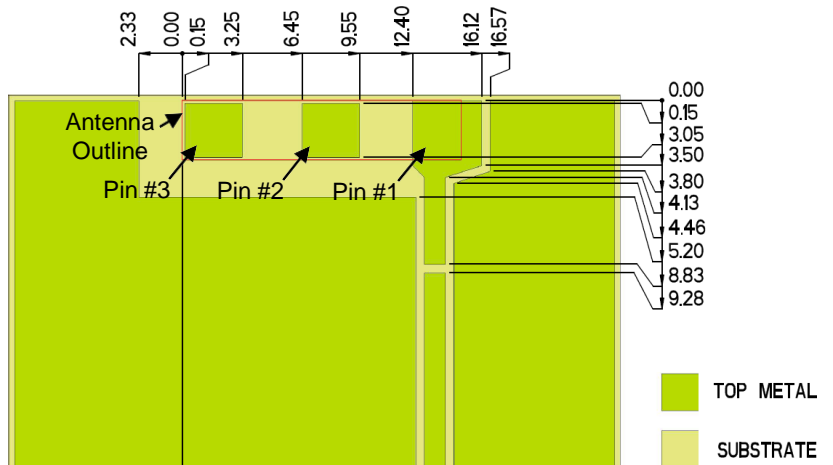

Matching Pi Network (Demo Board)

Component	Value	Tolerance
P1	DNI	N/A
S1	0Ω	N/A
P2	0.4pF	±0.25pF
P3	0Ω	N/A

*Actual matching values depend on customer design

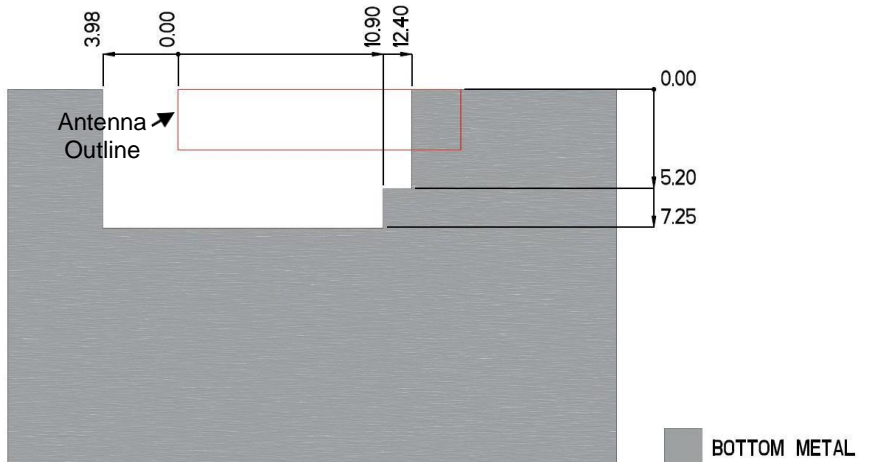
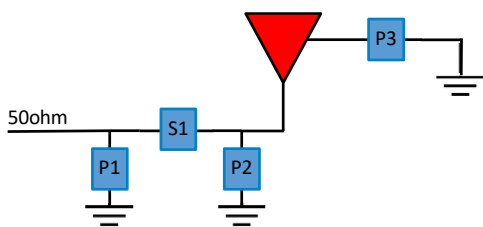

2.4 GHz KYOCERA AVX Automotive Embedded Antenna Specifications.
 KYOCERA AVX produces a wide variety of standard and custom antennas to meet user needs.

VSWR and Efficiency Plots (On-Ground)

Typical performance on 50 x 70 mm PCB

VSWR

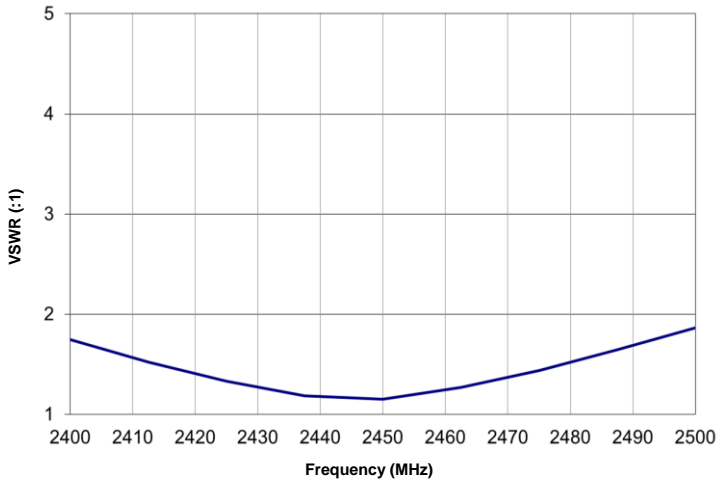

Efficiency

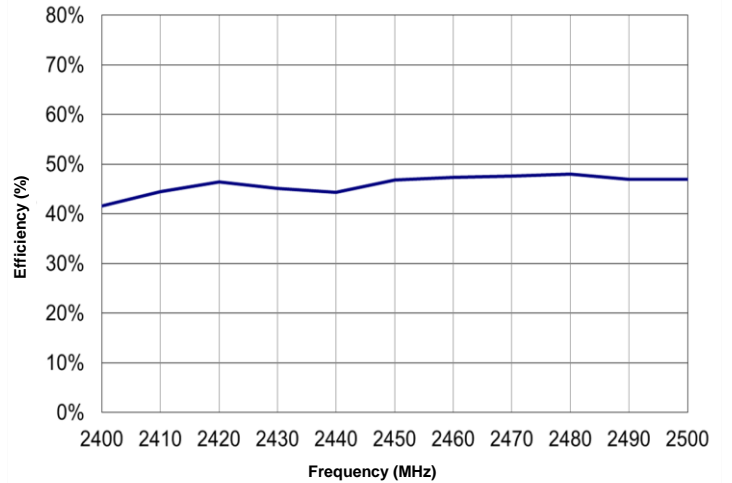

Antenna Radiation Patterns (On-Ground)

Typical performance on 50 x 70 mm PCB

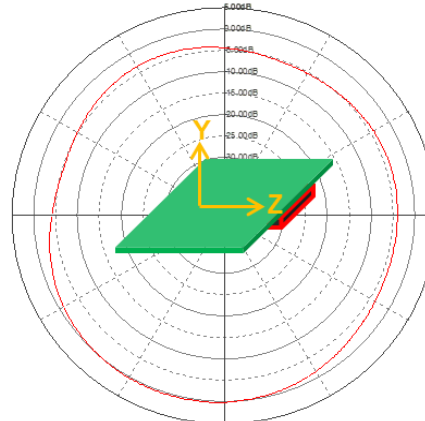
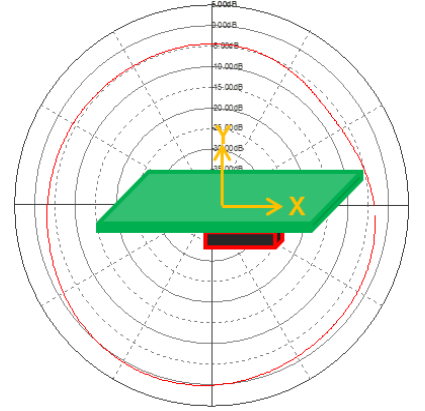
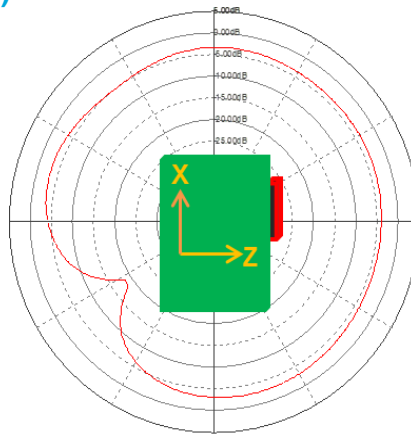
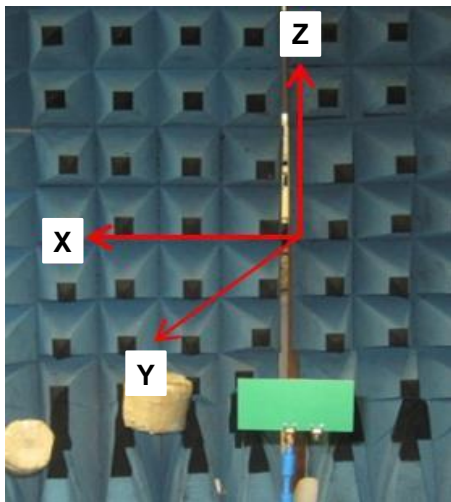

2.4 GHz KYOCERA AVX Automotive Embedded Antenna Specifications.
 KYOCERA AVX produces a wide variety of standard and custom antennas to meet user needs.

Antenna Layout (On-Ground)

Typical layout dimensions (mm)

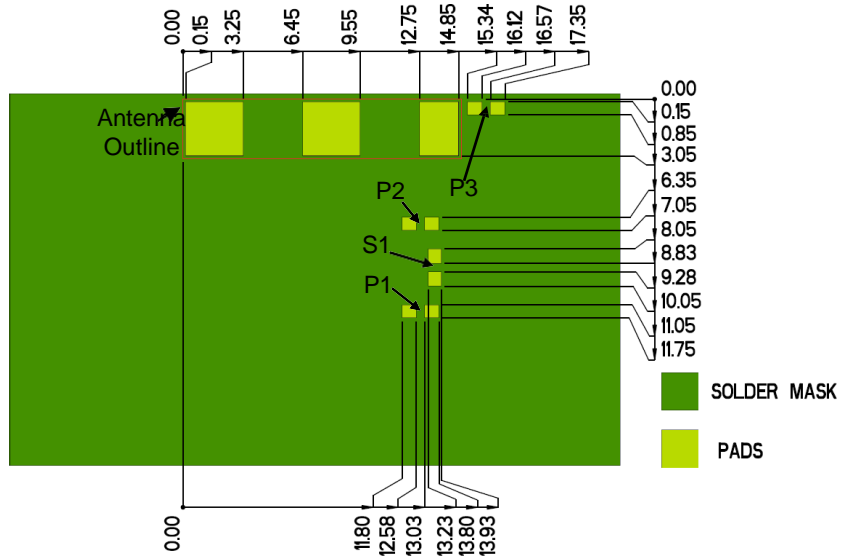
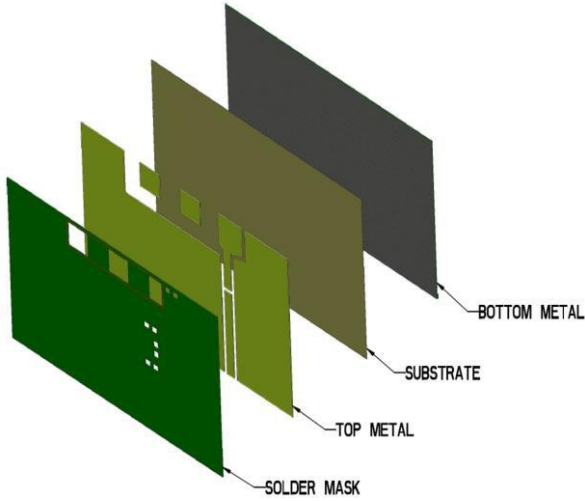

* VIAS: Diam. 0.2mm, (no vias on transmission lines).
 Via holes must be covered by solder mask

Pin Descriptions

Pin#	Description
1	Feed
2	Dummy Pad
3	Dummy Pad

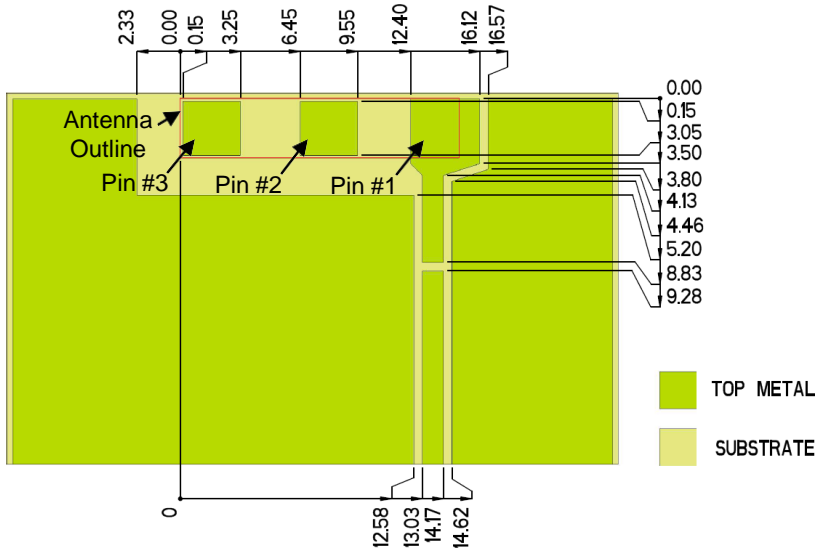

Matching Pi Network (Demo Board)

Component	Value	Tolerance
P1	DNI	N/A
S1	0Ω	N/A
P2	DNI	N/A
P3	0Ω	N/A

*Actual matching values depend on customer design

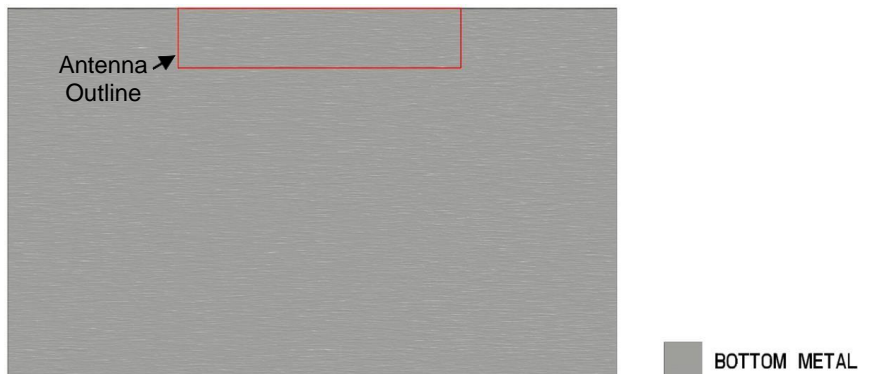
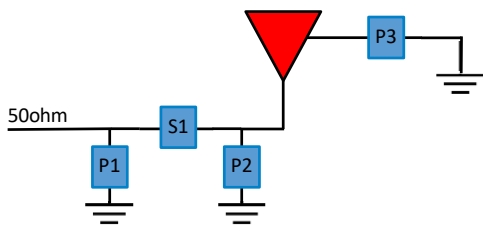

2.4 GHz KYOCERA AVX Automotive Embedded Antenna Specifications.
 KYOCERA AVX produces a wide variety of standard and custom antennas to meet user needs.

Antenna Demo Board
 1001013-02 Off-Ground

Part Number	A (mm)	B (mm)	C (mm)
1001013-02	70.0	50.0	15.0

