

# Part No. A1004795 / A1004796

## Automotive Embedded 5G / LTE / NTN / GNSS SMT Antenna

315 MHz / 400 MHz / 433 MHz / 450 MHz / 600 – 960 MHz / 1710 – 2690 MHz / 1525 – 1660 MHz /  
 1559 – 1610 MHz / 1980 – 2200 MHz

Supports: 5G, LTE, LTE CAT-M, NB-IoT, LoRa, Cellular, LPWA, ISM, GNSS, NTN (S-Band/L-Band)



\*Mirrored version offered as A1004796

### Automotive Embedded 5G / LTE / NTN / GNSS SMT Antenna

Low Band: 698 – 1000 MHz  
 Mid Band: 1700 – 2400 MHz  
 High Band: 2500 – 2700 MHz  
 Appendix 1: 315, 400, 433, 450 MHz  
 Appendix 2: 600 – 960 / 1710 – 2400 MHz /  
 1525 – 1600 MHz / 1559 – 1610 MHz /  
 1980 – 2200 MHz / 2500 – 2700 MHz

### KEY BENEFITS

#### Reduced Costs and Time-to-Market

Standard antenna eliminates design fees and cycle time associated with a custom solution; getting products to market faster.

#### Greater Flexibility with Unique Form Factors

KYOCERA AVX's technology helps you deliver more advanced ergonomic designs without adverse impact on product performance.

#### Environmental Compliance

Comply with latest RoHS, AECQ100 (Grade 0) requirements

### APPLICATIONS

- Smart metering
- IoT, Industrial devices
- Automotive
- Point of Sale
- Tracking
- Cellular
- Tracking
- Telematics
- Satellite IoT

KYOCERA AVX A-Series automotive antennas deliver on the key needs of device designers for higher functionality

KYOCERA AVX has completed rigorous testing to qualify the A-series antennas for automotive applications. Although the AEC-Q200 standard does not include antenna products, all testing has been done following applicable AEC-Q200 requirements and procedures as closely as possible. Customers must provide additional quality requirements, if any, to drive additional compliance testing.

### High Performance 5G / LTE / NTN / GNSS in Small form factor

This Automotive 5G/LTE antenna is designed to support all worldwide major carriers. In addition, the versatility to retune to other frequency bands, allows this antenna to perform at 315MHz for RKE applications, 450MHz for the LTE band B31, 433MHz ISM bands as well as 400MHz satellite applications. It's also supporting GNSS as well as NTN with coverage of S-Band and L-Band for IoT Satellite. This antenna is the perfect solution for automotive devices, offering high efficiency and peak gain in a small form factor, and with a reduced ground plane size requirement.

### Electrical Specifications

Typical A1004795 performance on 125 x 45 mm PCB

Frequency (MHz)	315, 400, 433, 450	600-698	698-960	1525 – 1600 1559 – 1610 1980 - 2200	1710-2400	2500-2700
Peak Gain	<i>Refer to Appendix 1</i>	<i>Refer to Appendix 2</i>	1.6 dBi	<i>Refer to Appendix 3</i>	3.1 dBi	1.7 dBi
Average Efficiency	<i>Refer to Appendix 1</i>	<i>Refer to Appendix 2</i>	64%	<i>Refer to Appendix 3</i>	55%	53%
VSWR	<i>Refer to Appendix 1</i>	<i>Refer to Appendix 2</i>	< 2.5:1	<i>Refer to Appendix 3</i>	< 2.5:1	< 3.0:1
Polarization	Linear					
Power Handling	2 Watt CW					
Feed Point Impedance	50 Ω unbalanced					

A1004795 / A1004796 Automotive Embedded 5G / LTE / NTN / GNSS KYOCERA AVX SMT Antenna Specifications.  
 KYOCERA AVX produces a wide variety of standard and custom antennas to meet user needs.

**Mechanical Specifications & Ordering Part Number**

Ordering Part #	A1004795 / A1004796
Dimensions (mm)	36.0 x 9.0 x 3.3
Mounting Type	SMT (P&P)
Weight (grams)	2.1
Packaging	Tape and Reel
Demo Board	1004795-01 (1004795) 1004796-01 (1004796)
Temperature Range	-50/+125 °C
Temperature Cycle	IEC 60068-2-14:2009
Temperature Exposure	Mil-STD-202 Method 108
High Temperature & High Humidity	MIL-STD-202
Mechanical Shock	IEC 60068-2-27:2008
Vibration	IEC 60068-2-6:2007
Additional Resources	<a href="#">Download DXF, Gerber and 3D FIT Files</a>
IMDS and PPAP available	

A1004795 / A1004796 Automotive Embedded 5G / LTE / NTN / GNSS KYOCERA AVX SMT Antenna Specifications.  
 KYOCERA AVX produces a wide variety of standard and custom antennas to meet user needs.

**LTE Bands covered by (A1004795/A1004796)**

LTE Band	Frequency Band (MHz)	Uplink (UL) (MHz)	Downlink (DL) (MHz)	Region	Covered
1	2100	1920 - 1980	2110 - 2170	Global	Yes
2	1900	1850 - 1910	1930 - 1990	NAM	
3	1800	1710 - 1785	1805 - 1880	Global	
4	1700	1710 - 1755	2110 - 2155	NAM	
5	850	824 - 849	869 - 894	NAM	
6	850	830 - 840	875 - 885	APAC	
7	2600	2500 - 2570	2620 - 2690	EMEA	
8	900	880 - 915	925 - 960	Global	
9	1800	1749.9 - 1784.9	1844.9 - 1879.9	APAC	
11	1500	1427.9 - 1447.9	1475.9 - 1495.9	Japan	No
12	700	699 - 716	729 - 746	NAM	Yes
13	700	777 - 787	746 - 756	NAM	
14	700	788 - 798	758 - 768	NAM	
17	700	704 - 716	734 - 746	NAM	
18	850	815 - 830	860 - 875	Japan	
19	850	830 - 845	875 - 890	Japan	
20	800	832 - 862	791 - 821	EMEA	No
21	1500	1447.9 - 1462.9	1495.9 - 1510.9	Japan	
22	3500	3410 - 3490	3510 - 3590	EMEA	
23	2000	2000 - 2020	2180 - 2200	NAM	Yes
24	1600	1626.5 - 1660.5	1525 - 1559	NAM	
25	1900	1850 - 1915	1930 - 1995	NAM	
26	850	814 - 849	859 - 894	NAM	
27	850	807 - 824	852 - 869	NAM	
28	700	703 - 748	758 - 803	APAC,EU	
29	700	N/A	717 - 728	NAM	
30	2300	2305 - 23151	2350 - 2360	NAM	No
31	450	452.5 - 457.5	462.5 - 467.5	Global	
32	1500	N/A	1452 - 1496	EMEA	
34	2000		2010 - 2025	EMEA	
35	1850		1850 - 1910	NAM	
38	2600		2570 - 2620	EMEA	
39	1900		1880 - 1920	China	
40	2300		2300 - 2400	China	
41	2500		2496 - 2690	Global	
42	3500		3400 - 3600	EU, Japan	
43	3700		3600 - 3800	-	No
48	3500		3550 - 3700	Global	Yes
65	2100	1920 - 2010	2110 - 2200	Global	
66	1700	1710 - 1780	2110 - 2200	NAM	
70	1700	1695 - 1710	1995 - 2020	NAM	
71	600		617 - 698	NAM	
74/75/76	1500		1427 - 1518	NAM	No
85	700	698 - 716	728 - 746	NAM	Yes

A1004795 / A1004796 Automotive Embedded 5G / LTE / NTN / GNSS KYOCERA AVX SMT Antenna Specifications.  
 KYOCERA AVX produces a wide variety of standard and custom antennas to meet user needs.

5G Bands covered by (A1004795/A1004796)

5G Band	Frequency Band (MHz)	Uplink (UL) (MHz)	Downlink (DL) (MHz)	Region	Covered
1	2100	1920 - 1980	2110 - 2170	Global	Yes
2	1900	1850 - 1910	1930 - 1990	NAM	
3	1800	1710 - 1785	1805 - 1880	Global	
5	850	824 - 849	869 - 894	NAM	
7	2600	2500 - 2570	2620 - 2690	EMEA	
8	900	880 - 915	925 - 960	Global	
12	700	699 - 716	729 - 746	NAM	
13	700	777 - 787	746 - 756	-	
14	700	788 - 798	758 - 768	-	
18	850	815 - 830	860 - 875	Japan	
20	800	832 - 862	791 - 821	EMEA	
23	2100	2000 - 2020	2180 - 2200	-	
25	1900	1850 - 1915	1930 - 1995	NAM	
26	850	814 - 849	859 - 894	-	
28	700	703 - 748	758 - 803	APAC, EU	
29	700	N/A	717 - 728	-	
30	2300	2305 - 2315	2350 - 2360	-	
38	2600	2570 - 2620	N/A	EMEA	
40	2300	2300 - 2400	N/A	China	
41	2500	2496 - 2690	N/A	Global	
48	3500	3550 - 3700	N/A	NAM	
53	2400	2483.5 - 2495		-	No
66	1700	1710 - 1780	2110 - 2200	NAM	Yes
70	2000	1695 - 1710	1995 - 2020	NAM	
71	600	663 - 698	617 - 652	NAM	
75	1500	N/A	1432 - 1517	NAM	No
76	1500	N/A	1427 - 1432	NAM	
77	3700	3300 - 4200	N/A	-	
78	3500	3300 - 3800	N/A	-	
79	4700	4400 - 5000	N/A	-	Yes
255	1600	1626.5 - 1660.5	1525 - 1559	-	
256	2100	1980 - 2010	2170 - 2200	-	
257	28000	26500 - 29500		Global	No
258	26000	24250 - 27500		Global	
260	39000	37000 - 40000		Global	
261	28000	27500 - 28550		NAM	

A1004795 / A1004796 Automotive Embedded 5G / LTE / NTN / GNSS KYOCERA AVX SMT Antenna Specifications.  
 KYOCERA AVX produces a wide variety of standard and custom antennas to meet user needs.

### Antenna Dimensions (A1004795)

Typical antenna dimensions (mm)

Part Number	A (mm)	B (mm)	C (mm)
A1004795	36.0 ± 0.2	9.0 ± 0.2	3.3 ± 0.33

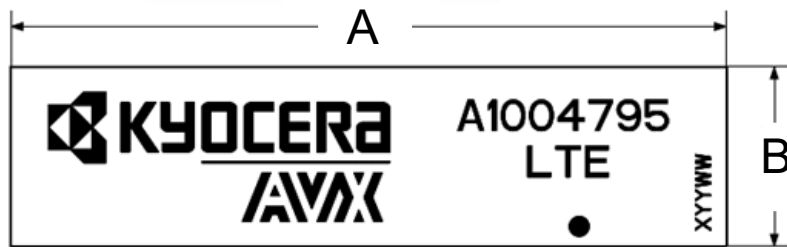

Top View

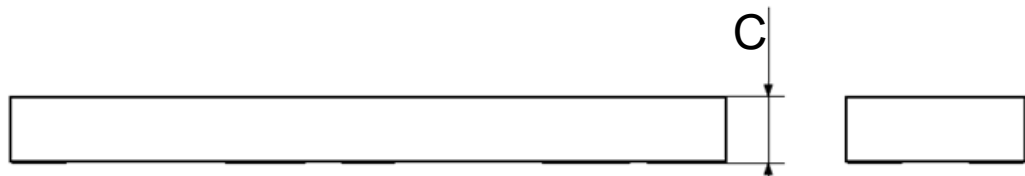

Front View/Height

Pin#	Description
1	Feed
2	Antenna Tuning
3	Dummy Pad
4	Dummy Pad
5	Antenna Tuning
6	Dummy Pad
7	Dummy Pad
8	Dummy Pad

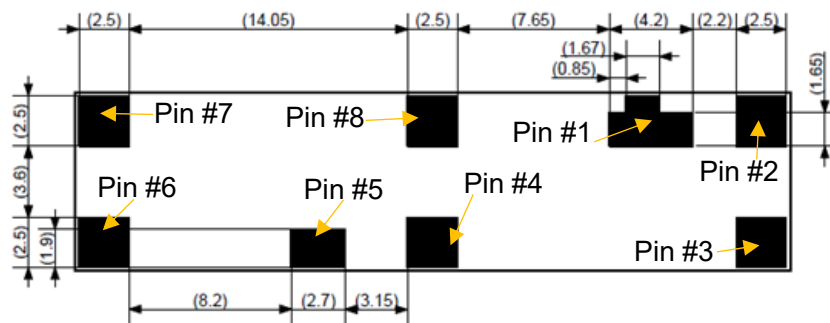

Bottom View

A1004795 / A1004796 Automotive Embedded 5G / LTE / NTN / GNSS KYOCERA AVX SMT Antenna Specifications.  
 KYOCERA AVX produces a wide variety of standard and custom antennas to meet user needs.

**Antenna Dimensions (A1004796)**

Typical antenna dimensions (mm)

Part Number	A	B	C
A1004796	36.0 ± 0.2	9.0 ± 0.2	3.3 ± 0.33

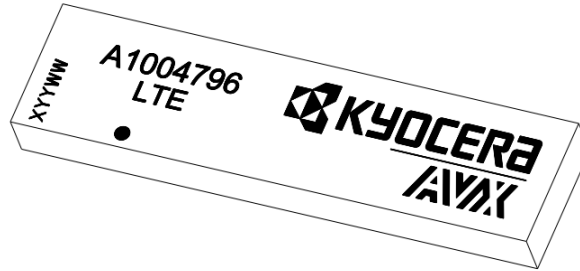

**Top View**



**Front View/Height**

Pin#	Description
1	Feed
2	Antenna Tuning
3	Dummy Pad
4	Dummy Pad
5	Antenna Tuning
6	Dummy Pad
7	Dummy Pad
8	Dummy Pad

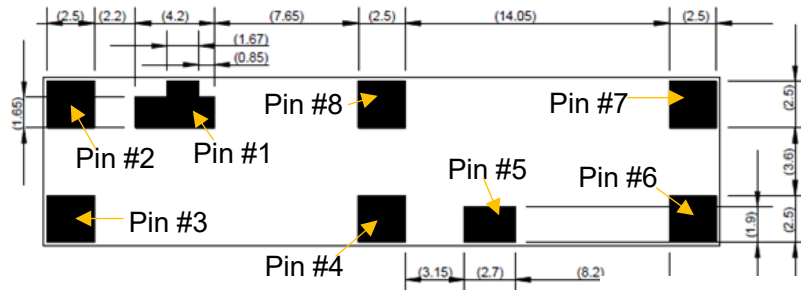

**Bottom View**

A1004795 / A1004796 Automotive Embedded 5G / LTE / NTN / GNSS KYOCERA AVX SMT Antenna Specifications.  
 KYOCERA AVX produces a wide variety of standard and custom antennas to meet user needs.

### VSWR and Efficiency Plots

Typical A1004795/A1004796 performance 125 x 45 mm PCB

**Low Band VSWR**

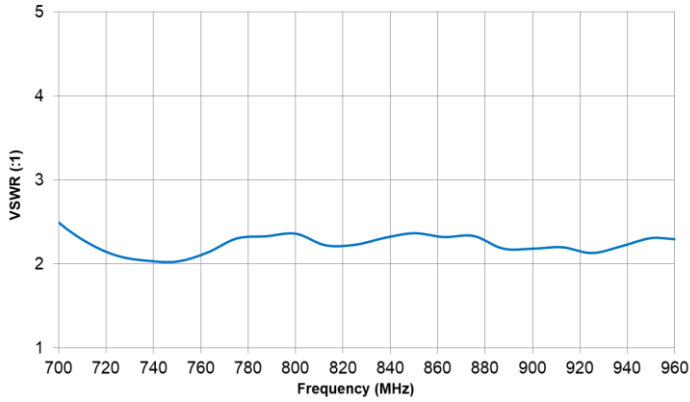

**Low Band Efficiency**

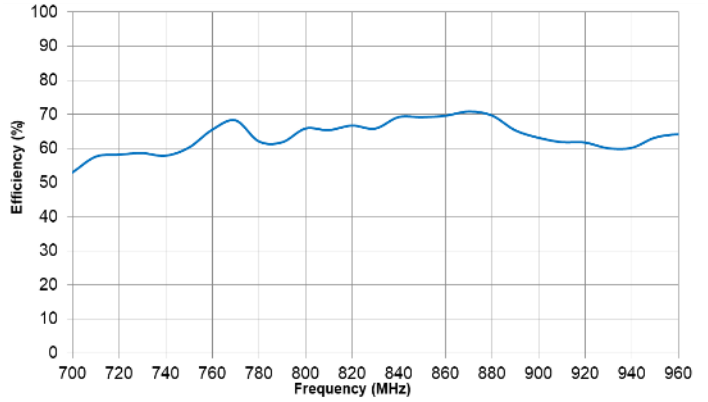

**High Band VSWR**

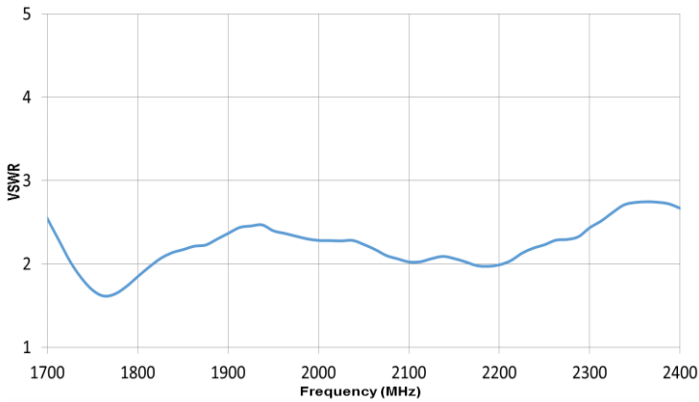

**High Band Efficiency**

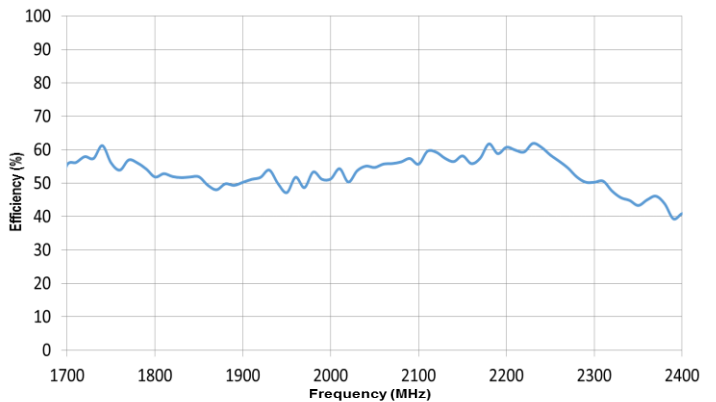

**Band 7 VSWR**

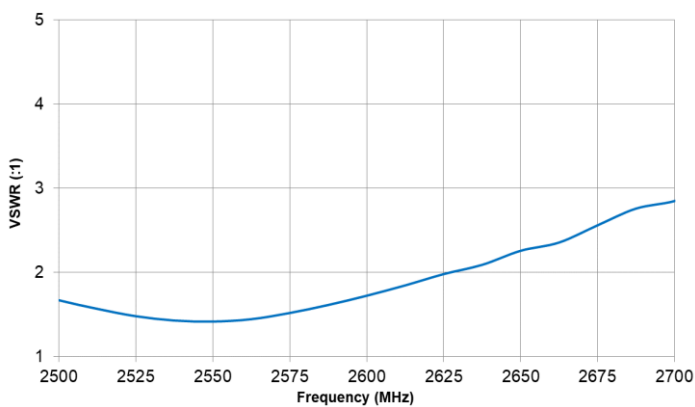

**Band 7 Efficiency**

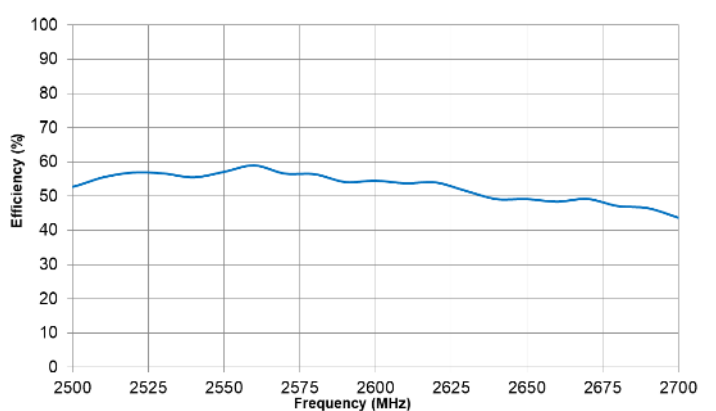

A1004795 / A1004796 Automotive Embedded 5G / LTE / NTN / GNSS KYOCERA AVX SMT Antenna Specifications.  
 KYOCERA AVX produces a wide variety of standard and custom antennas to meet user needs.

### Antenna Radiation Patterns – Low / High Band

Typical A1004795/A1004796 performance 125 x 45 mm PCB

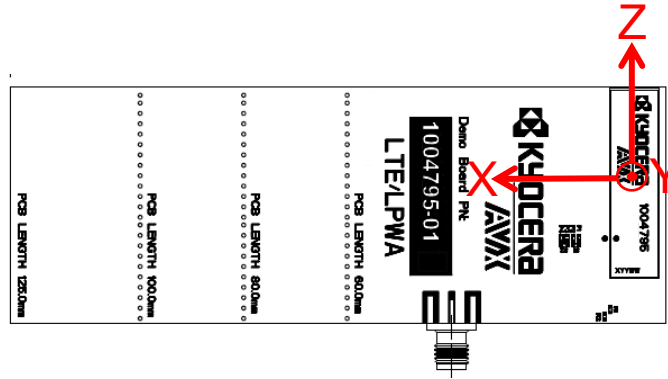

Low Band measured at  
700, 750, 850, 900 MHz

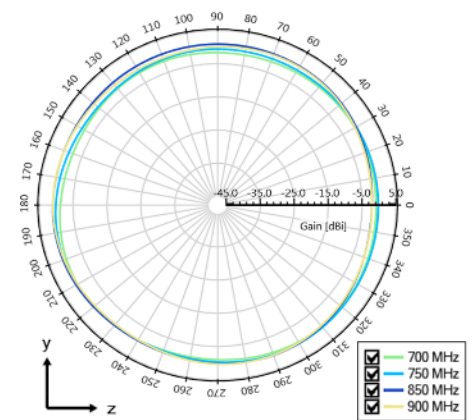
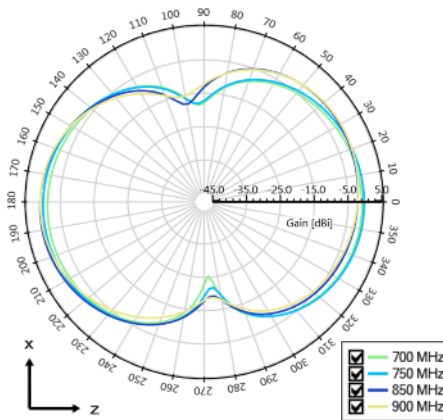
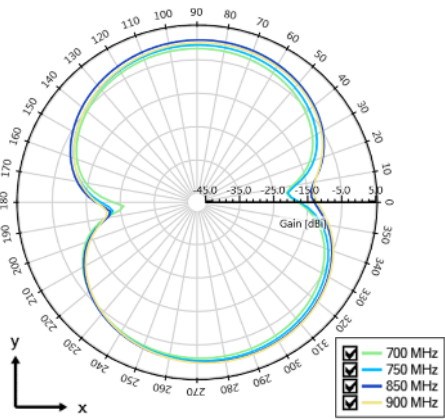

High Band measured at  
1800, 1900, 2100 MHz

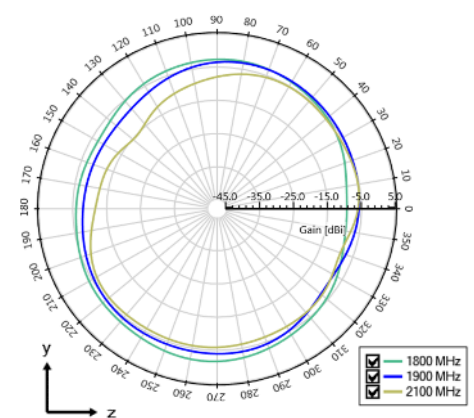
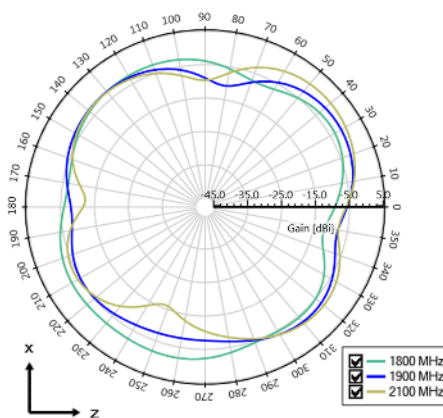
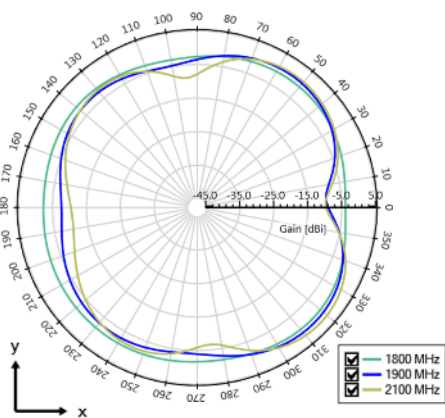

A1004795 / A1004796 Automotive Embedded 5G / LTE / NTN / GNSS KYOCERA AVX SMT Antenna Specifications.  
 KYOCERA AVX produces a wide variety of standard and custom antennas to meet user needs.

### Antenna Radiation Patterns – High Band, Band 7

Typical A1004795/A1004796 performance 125 x 45 mm PCB

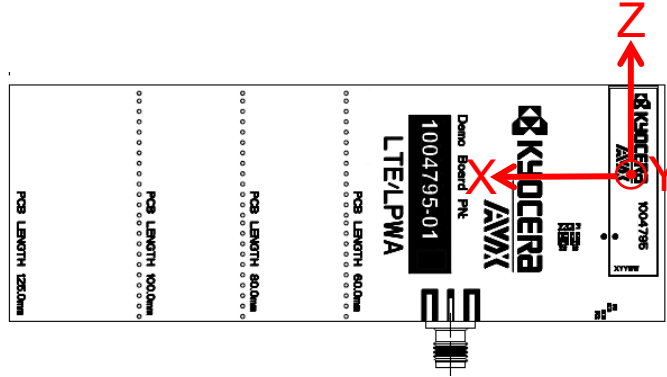

High Band measured at 2350 MHz

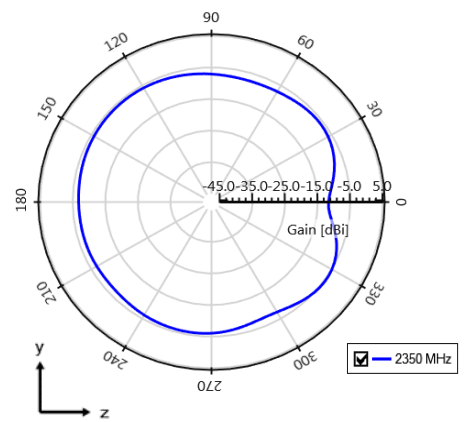
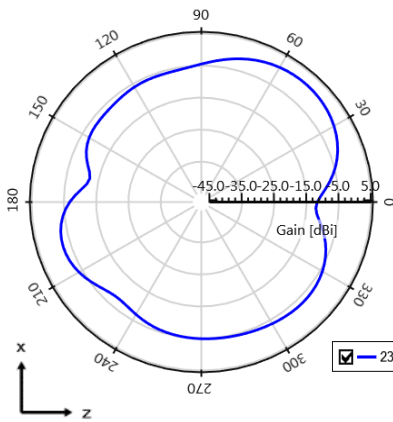
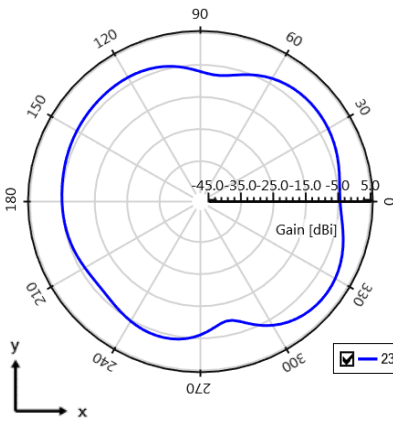

Band 7 measured at 2600 MHz

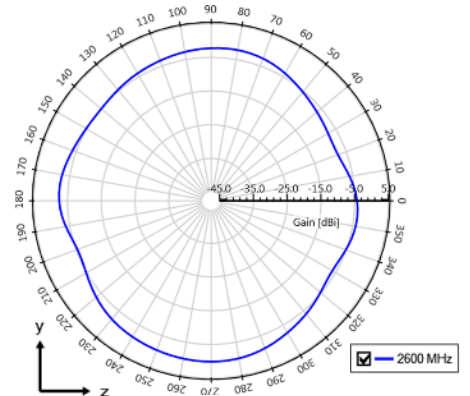
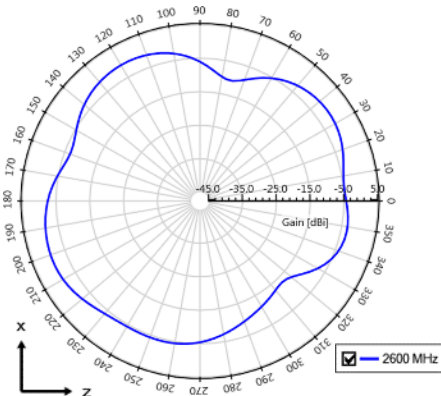
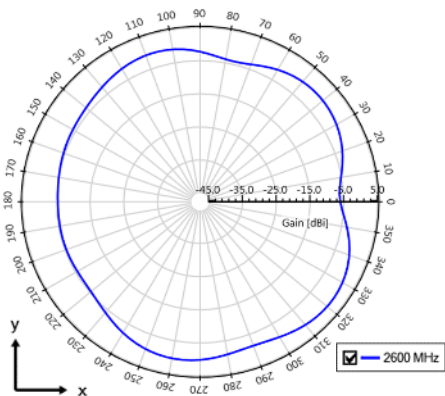

A1004795 / A1004796 Automotive Embedded 5G / LTE / NTN / GNSS KYOCERA AVX SMT Antenna Specifications. KYOCERA AVX produces a wide variety of standard and custom antennas to meet user needs.

### Antenna Layout (A1004795)

Typical layout dimensions (mm)

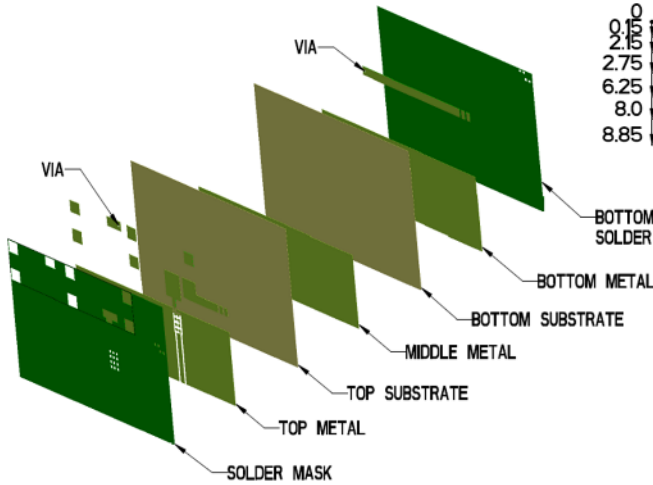

- Additional VIAS: Diam. 0.4mm to be placed around antenna, (no vias on transmission lines).
- Via holes must be covered by solder mask

### Pin Descriptions

Pin#	Description
1	Feed
2	Antenna Tuning
3	Dummy Pad
4	Dummy Pad
5	Antenna Tuning
6	Dummy Pad
7	Dummy Pad
8	Dummy Pad

Default Pi Matching Network values with instructions can be found under Antenna Matching Network.

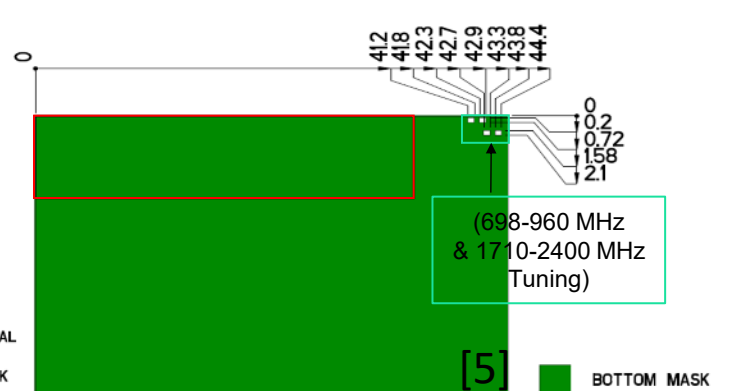
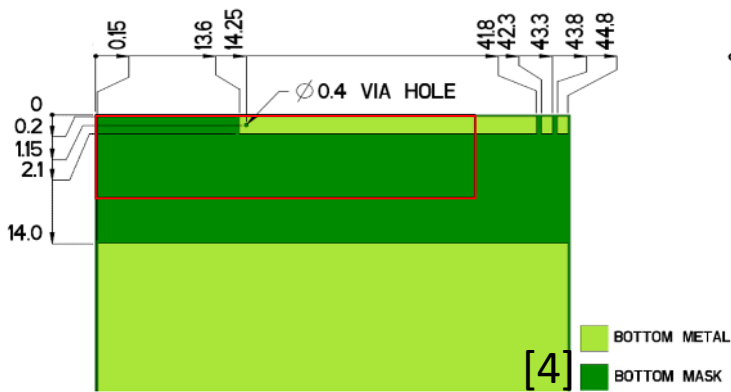
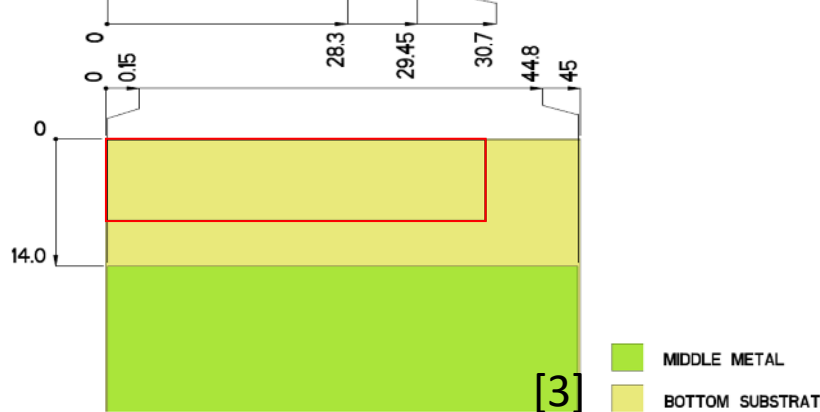
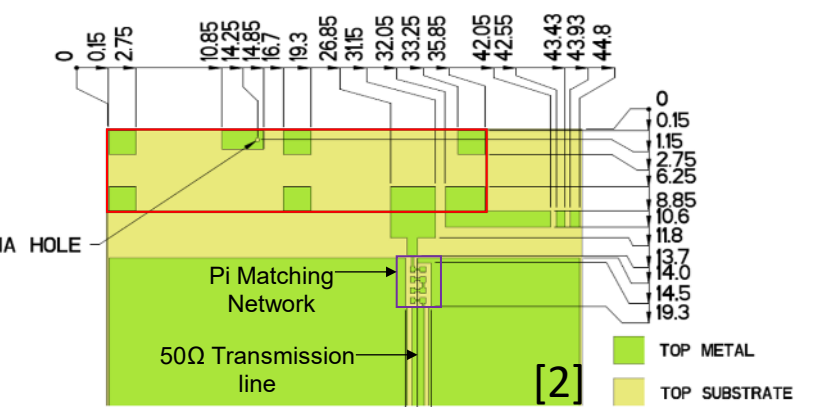
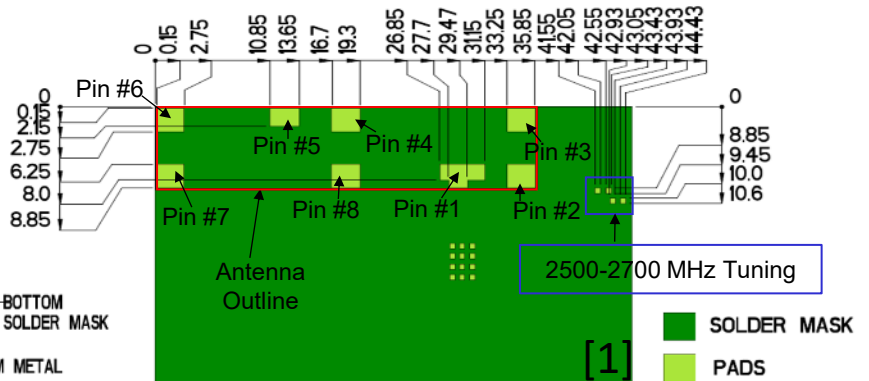

A1004795 / A1004796 Automotive Embedded 5G / LTE / NTN / GNSS KYOCERA AVX SMT Antenna Specifications. KYOCERA AVX produces a wide variety of standard and custom antennas to meet user needs.

### Antenna Layout (A1004796)

Typical layout dimensions (mm)

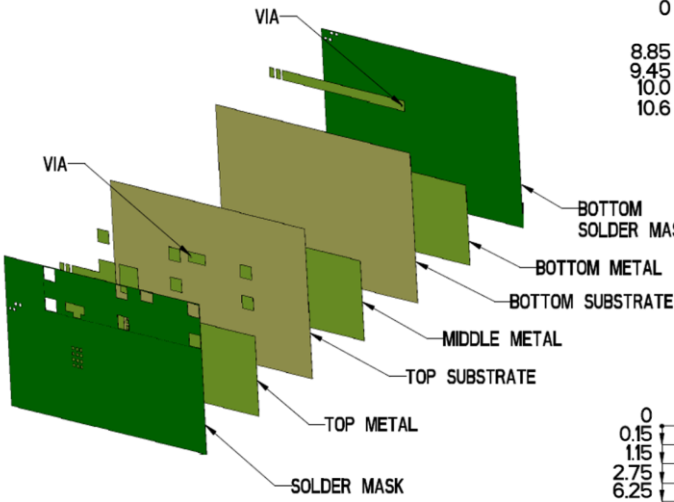

- Additional VIAS: Diam. 0.4mm to be placed around antenna, (no vias on transmission lines).
- Via holes must be covered by solder mask

### Pin Descriptions

Pin#	Description
1	Feed
2	Antenna Tuning
3	Dummy Pad
4	Dummy Pad
5	Antenna Tuning
6	Dummy Pad
7	Dummy Pad
8	Dummy Pad

\*1004795 uses the same layout but mirrored.

Default Pi Matching Network values with instructions can be found under Antenna Matching Network.

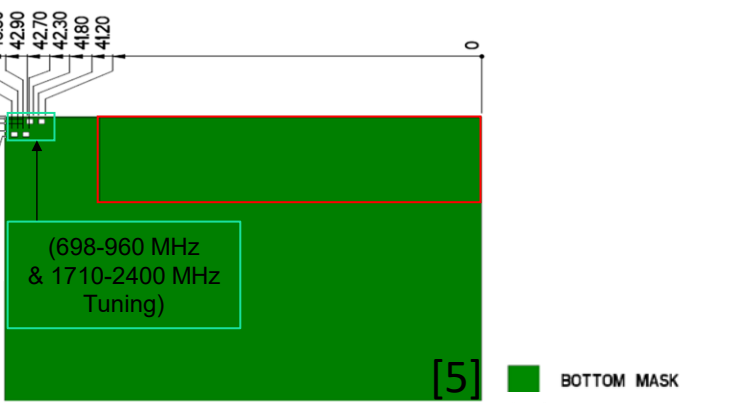
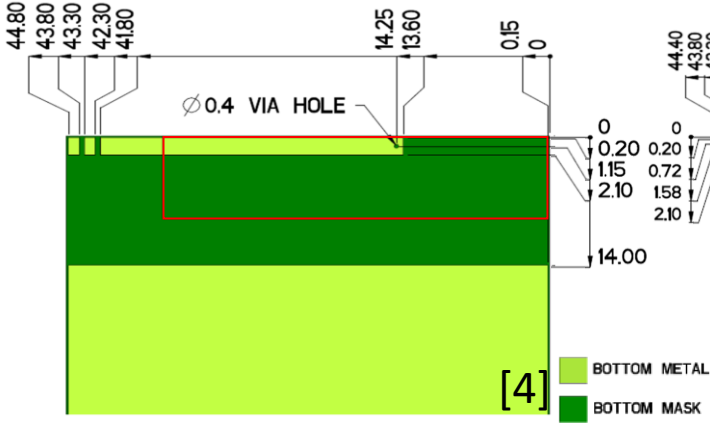
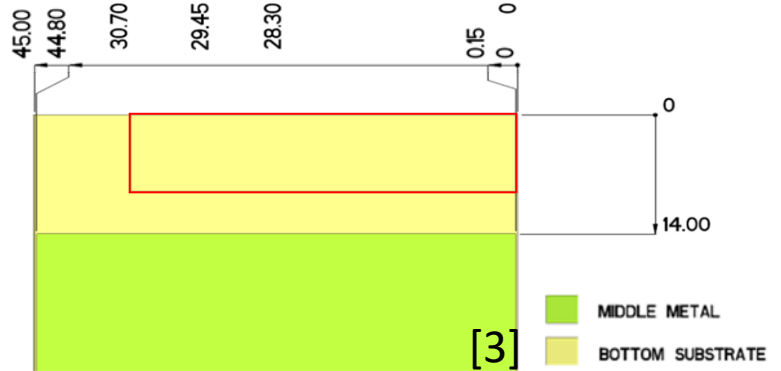
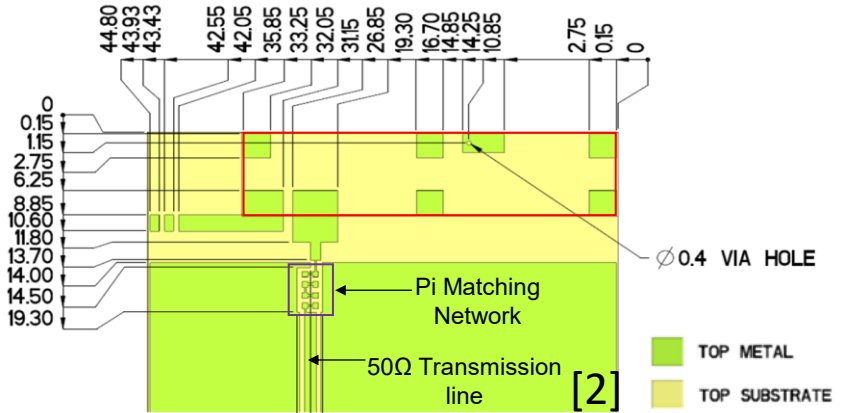
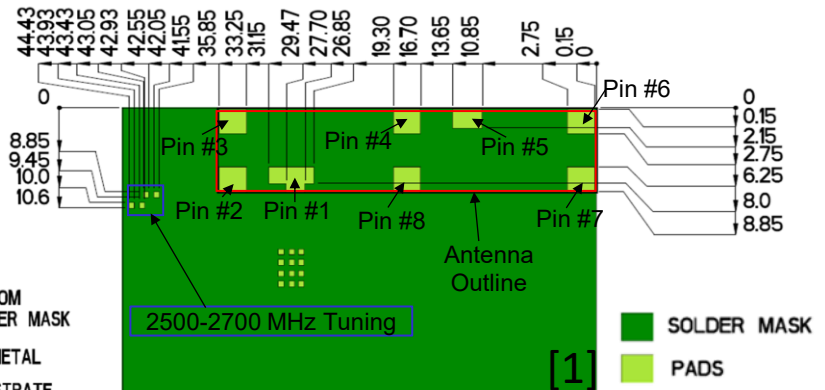

A1004795 / A1004796 Automotive Embedded 5G / LTE / NTN / GNSS KYOCERA AVX SMT Antenna Specifications.  
 KYOCERA AVX produces a wide variety of standard and custom antennas to meet user needs.

### Antenna Matching Structure (A1004795)

Typical matching values on 125 x 45 mm PCB

Demo Board Front View

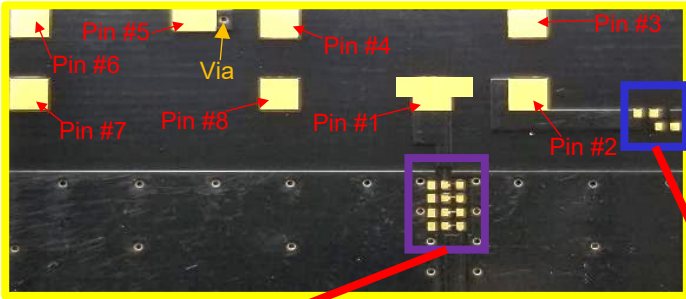

Demo Board Back View

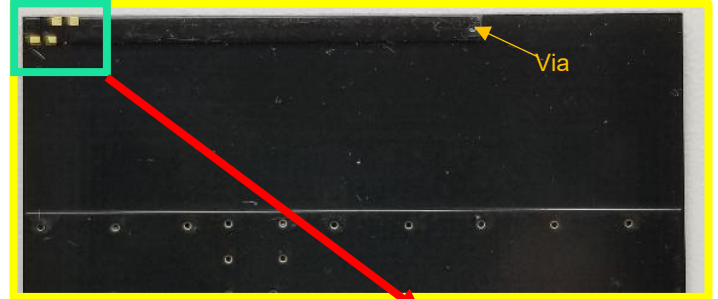

Antenna Matching

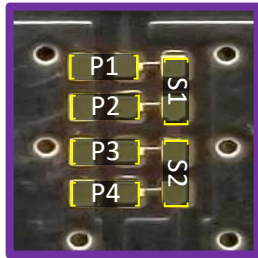

(Antenna Matching): pads are directly inline with the antenna feed trace.

2500-2700 MHz Tuning

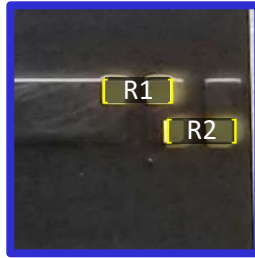

698-960 MHz & 1710-2400 MHz Tuning

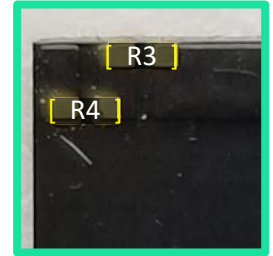

#### Pin Descriptions

Pin#	Description
1	Feed
2	Antenna Tuning
3	Dummy Pad
4	Dummy Pad
5	Antenna Tuning
6	Dummy Pad
7	Dummy Pad
8	Dummy Pad

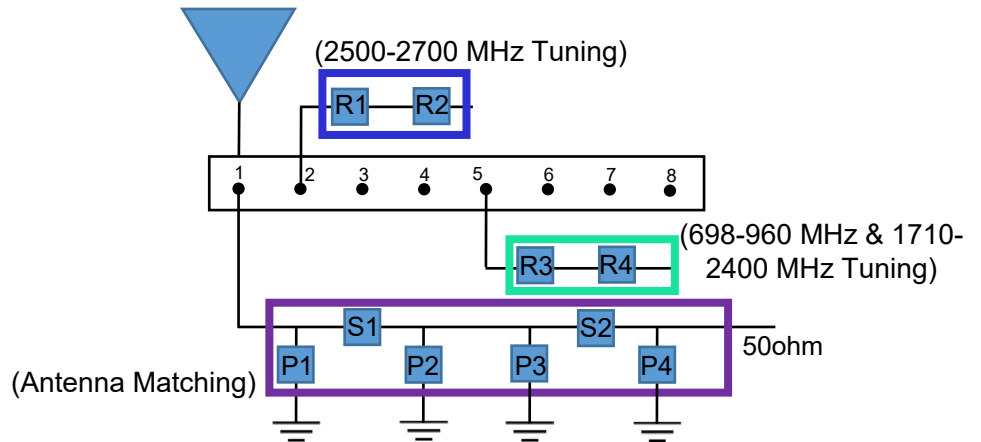

	P1	S1	P2	P3	S2	P4	R1	R2	R3-R4
<b>Default Matching</b>	8.2nH	4.7pF	0.3pF	N/A	0 Ohm	0.5pF	0 Ohm	N/A	0 Ohm
<b>Tolerance</b>	± 0.1nH	± 0.05pF	± 0.05pF	N/A	N/A	± 0.05pF	N/A	N/A	N/A

A1004795 / A1004796 Automotive Embedded 5G / LTE / NTN / GNSS KYOCERA AVX SMT Antenna Specifications.  
 KYOCERA AVX produces a wide variety of standard and custom antennas to meet user needs.

**Antenna Tuning Options (A1004795)**

Typical matching values on 125 x 45 mm PCB

Demo Board Front View

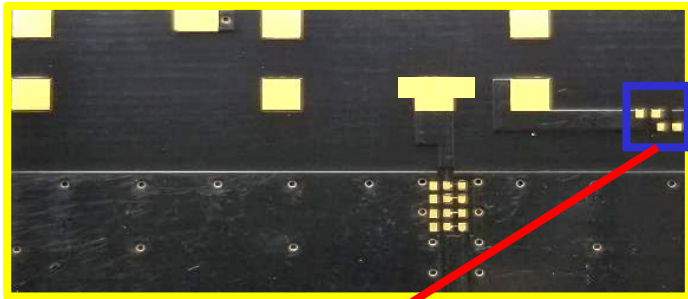

2500-2700 MHz Tuning

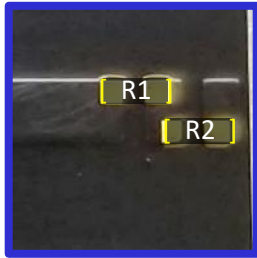

Demo Board Back View

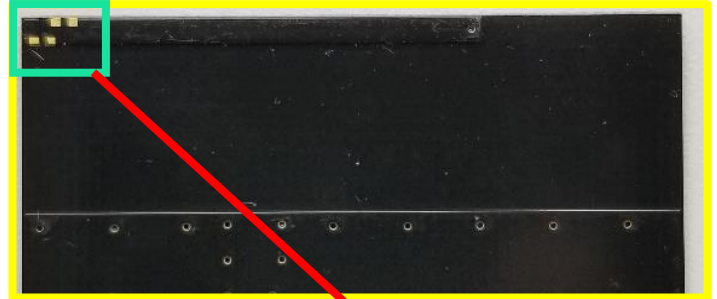

698-960 MHz  
& 1710-2400 MHz Tuning

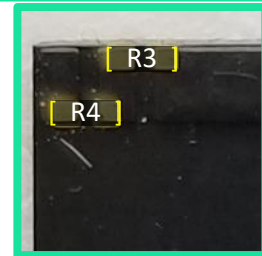

Options for Tuning: "698-960 MHz & 1710-2400 MHz"

MODE	T1	T2		T3	
PADS	Connect: R3 & R4	Remove: R4		Remove: R4 & R3	
Outcome: (Ref: Baseline)	BASELINE	(698-960 MHz) ~20 MHz shift high	(1710-2400 MHz) ~20 MHz shift high	(698-960 MHz) ~30 MHz shift high	(1710-2400 MHz) ~35 MHz shift high

\*R= 0 Ohm

Options for Tuning: "2500-2700 MHz"

MODE	T4	T5	T6
PADS	Connect: R1	Connect: R1 & R2	Remove: R1 & R2
Outcome: (Ref: Baseline)	BASELINE	~60 MHz shift low	~70 MHz shift high

\*R= 0 Ohm

A1004795 / A1004796 Automotive Embedded 5G / LTE / NTN / GNSS KYOCERA AVX SMT Antenna Specifications.  
 KYOCERA AVX produces a wide variety of standard and custom antennas to meet user needs.

**Antenna Demo Board (1004795-01)**

Demo Board Front/Back View (mm)

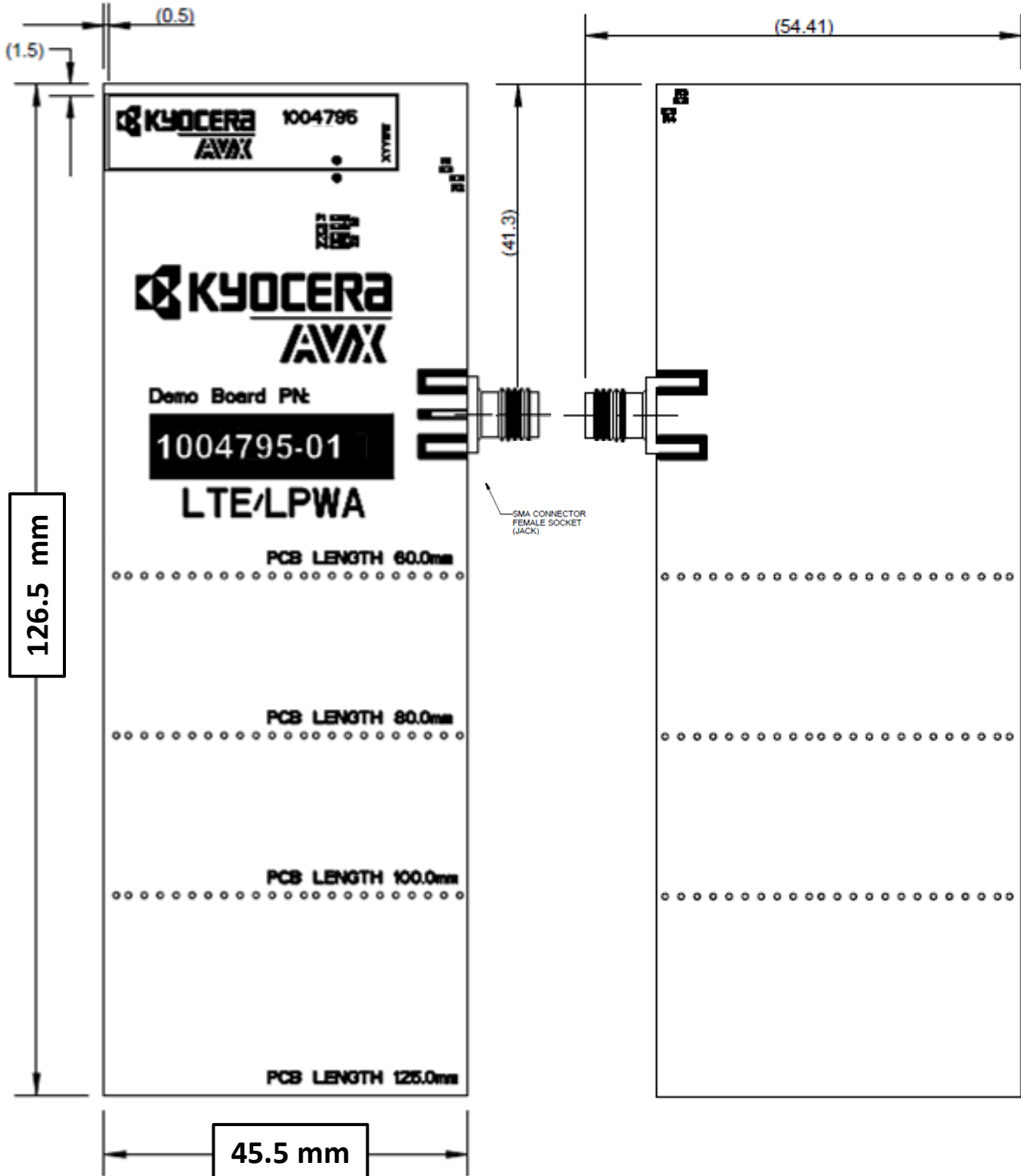

A1004795 / A1004796 Automotive Embedded 5G / LTE / NTN / GNSS KYOCERA AVX SMT Antenna Specifications.  
 KYOCERA AVX produces a wide variety of standard and custom antennas to meet user needs.

**Antenna Demo Board (1004796-01)**

Demo Board Front/Back View (mm)

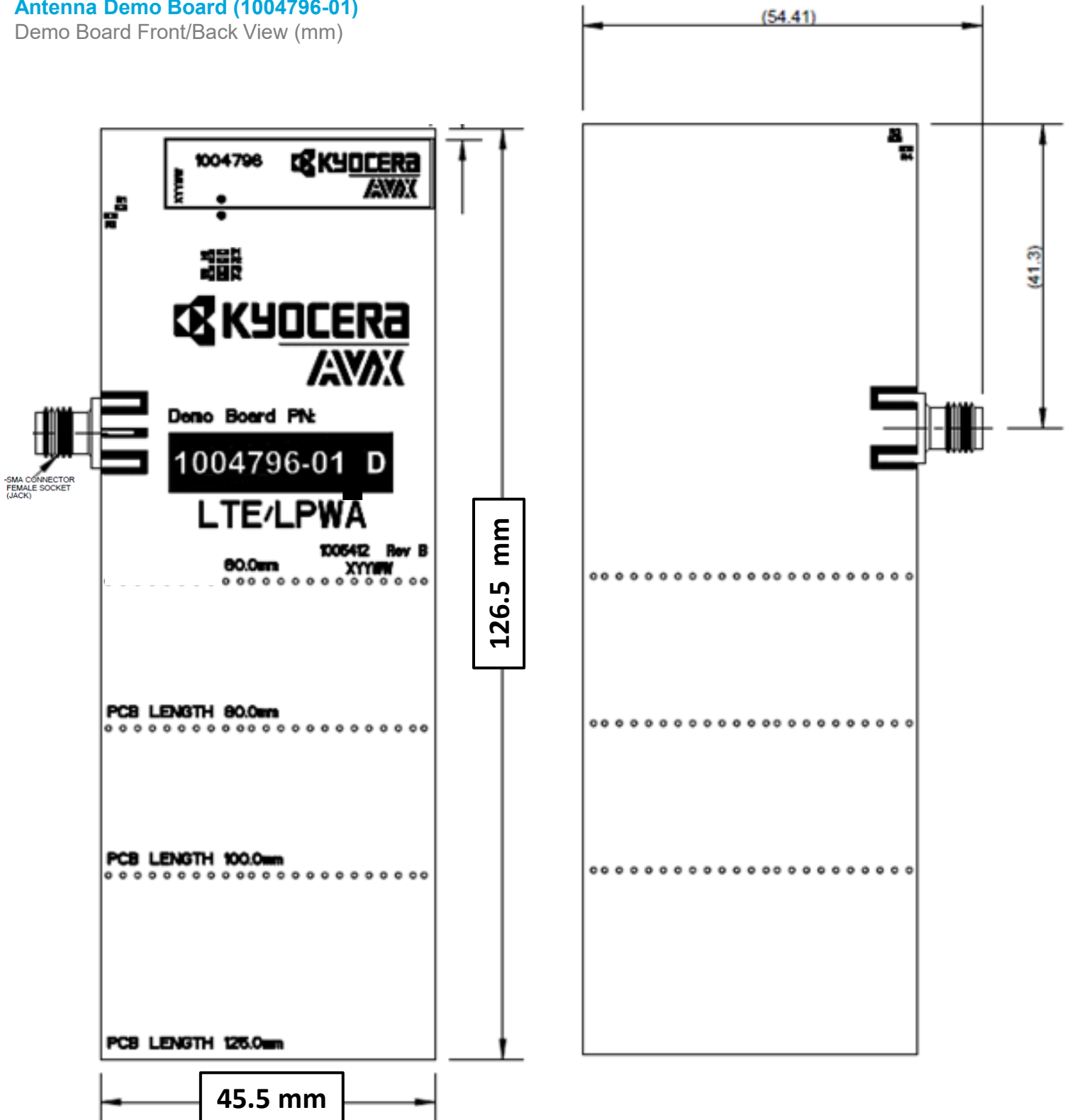

A1004795 / A1004796 Automotive Embedded 5G / LTE / NTN / GNSS KYOCERA AVX SMT Antenna Specifications.  
 KYOCERA AVX produces a wide variety of standard and custom antennas to meet user needs.

# Appendix 1

Appendix 1 gives instructions on how to achieve coverage at low frequency through impedance matching network.

(315 MHz / 400 MHz / 433 MHz / 450 MHz )

Frequency (MHz)	315	400	433	450
Peak Gain	-3.0 dBi	-3.0 dBi	-1.8 dBi	-3.0 dBi
Average Efficiency	17%	21%	26%	23%
VSWR Match	< 1.5:1			
Polarization	Linear			
Power Handling	2 Watt CW			
Feed Point Impedance	50 $\Omega$ unbalanced			

\*Data shown above has Appendix 1 matching applied on 125 x 45 mm pcb.

A1004795 / A1004796 Automotive Embedded 5G / LTE / NTN / GNSS KYOCERA AVX SMT Antenna Specifications.  
 KYOCERA AVX produces a wide variety of standard and custom antennas to meet user needs.

**Appendix 1: Antenna Matching Structure (A1004795)**

Typical matching values on 125 x 45 mm PCB

Demo Board Front View

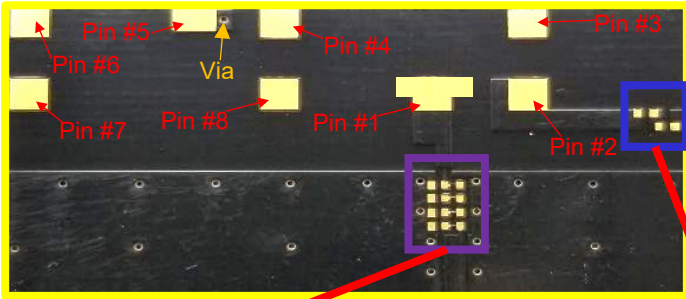

Demo Board Back View

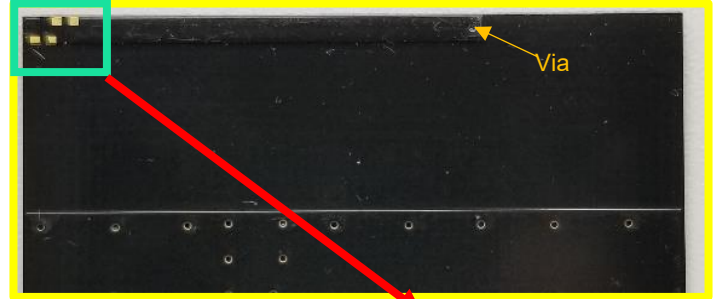

Antenna Matching

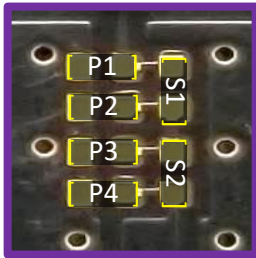

(Antenna Matching):  
 pads are directly inline with  
 the antenna feed trace.

Frontside Tuning

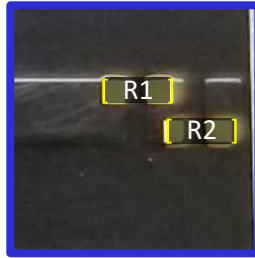

Backside Tuning

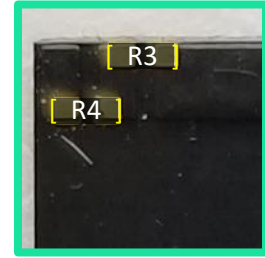

Pin Descriptions

Pin#	Description
1	Feed
2	Antenna Tuning
3	Dummy Pad
4	Dummy Pad
5	Antenna Tuning
6	Dummy Pad
7	Dummy Pad
8	Dummy Pad

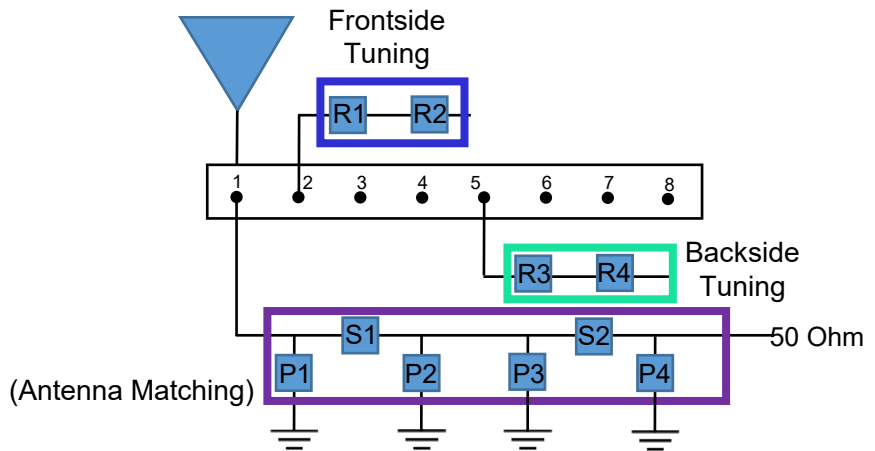

Frequency	P1	S1	P2	P3	S2	P4	R1	R2	R3-R4
315 MHz	N/A	120nH	12pF	N/A	18nH	N/A	0 Ohm	N/A	0 Ohm
400 MHz	N/A	75nH	10pF	N/A	0 Ohm	N/A	0 Ohm	N/A	0 Ohm
433 MHz	N/A	62nH	12pF	N/A	0 Ohm	N/A	0 Ohm	N/A	0 Ohm
450 MHz	N/A	56nH	12pF	N/A	0 Ohm	N/A	0 Ohm	N/A	0 Ohm

A1004795 / A1004796 Automotive Embedded 5G / LTE / NTN / GNSS KYOCERA AVX SMT Antenna Specifications.  
 KYOCERA AVX produces a wide variety of standard and custom antennas to meet user needs.

### Appendix 1: VSWR, Efficiency, and Peak Gain Plots

Typical A1004795 performance 125 x 45 mm PCB

**VSWR**  
(300 – 470 MHz)

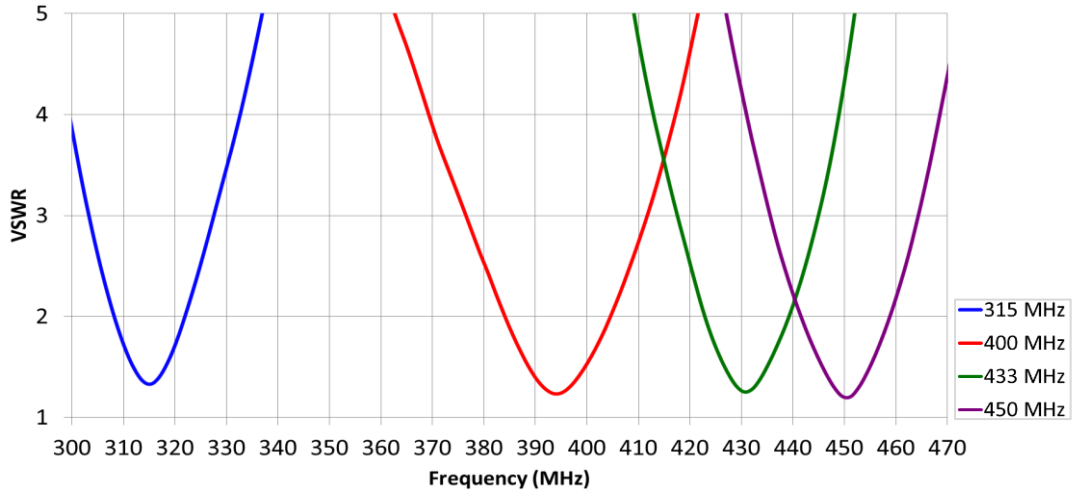

**Efficiency**  
(300 – 470 MHz)

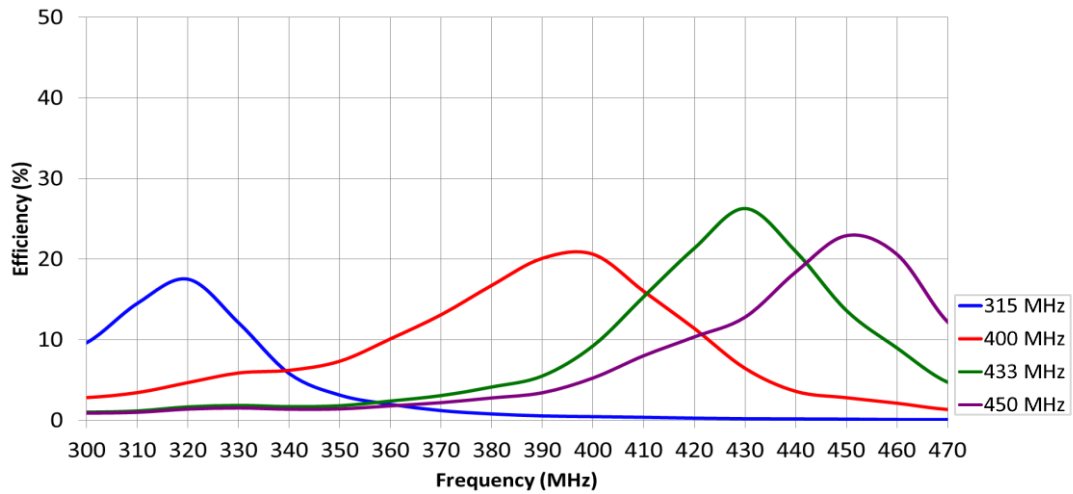

**Peak Gain**  
(300 – 470 MHz)

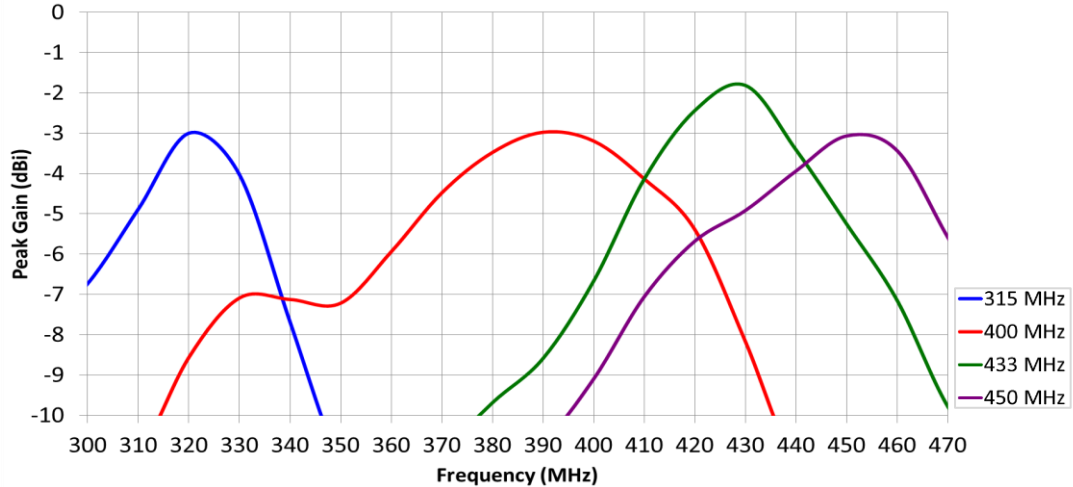

A1004795 / A1004796 Automotive Embedded 5G / LTE / NTN / GNSS KYOCERA AVX SMT Antenna Specifications.  
 KYOCERA AVX produces a wide variety of standard and custom antennas to meet user needs.

**Appendix 1: Antenna Radiation Patterns – 315 MHz and 400 MHz**

Typical A1004795 performance 125 x 45 mm PCB

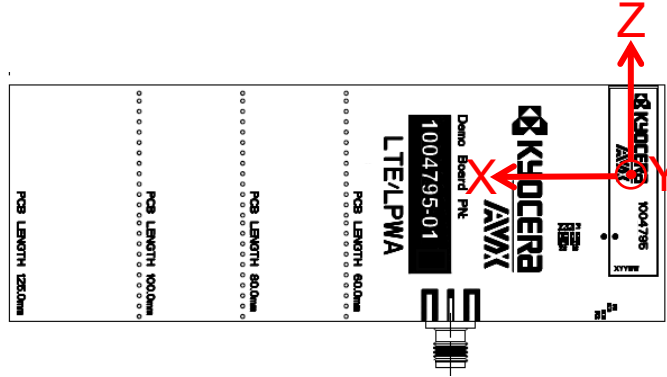

Measured at 315 MHz

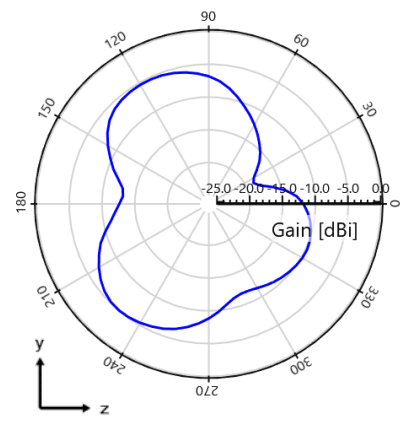
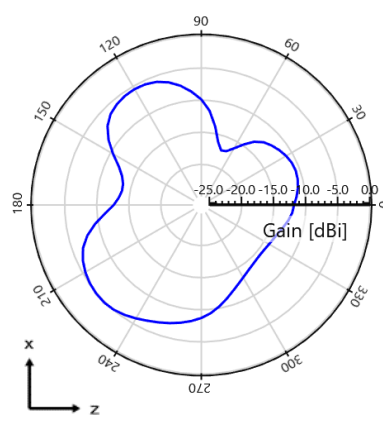
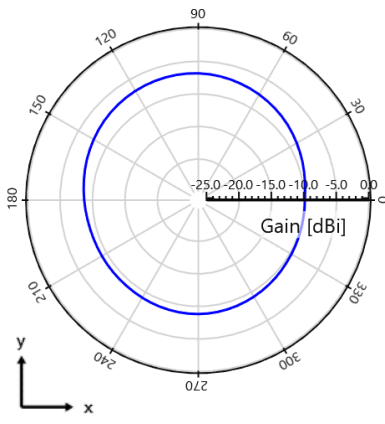

Measured at 400 MHz

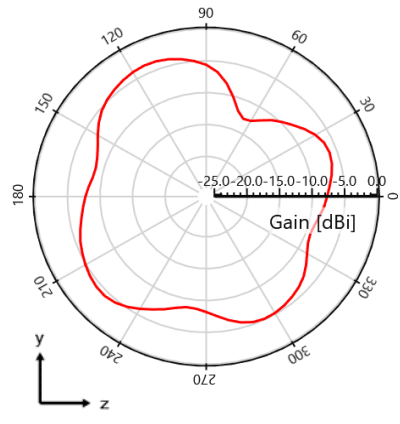
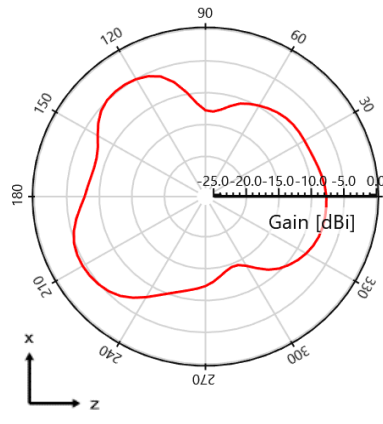
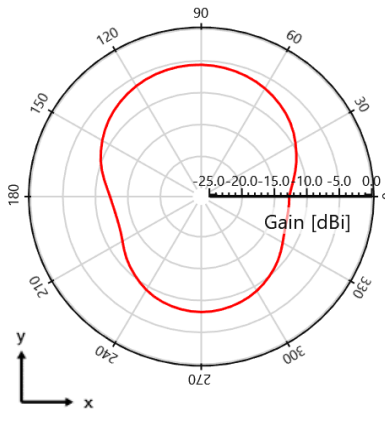

A1004795 / A1004796 Automotive Embedded 5G / LTE / NTN / GNSS KYOCERA AVX SMT Antenna Specifications.  
 KYOCERA AVX produces a wide variety of standard and custom antennas to meet user needs.

**Appendix 1: Antenna Radiation Patterns – 433 MHz and 450 MHz**

Typical A1004795 performance 125 x 45 mm PCB

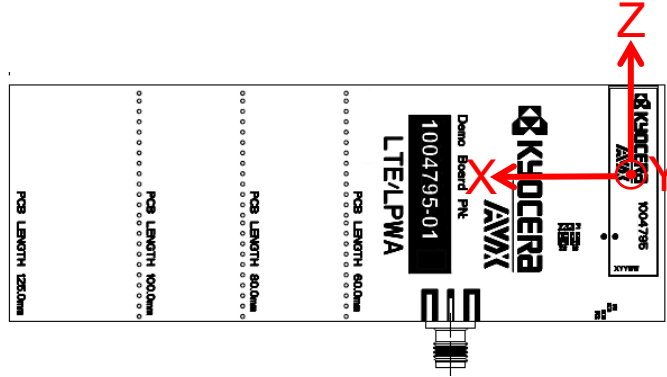

Measured at 433 MHz

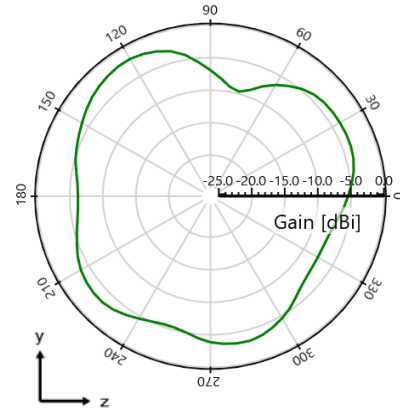
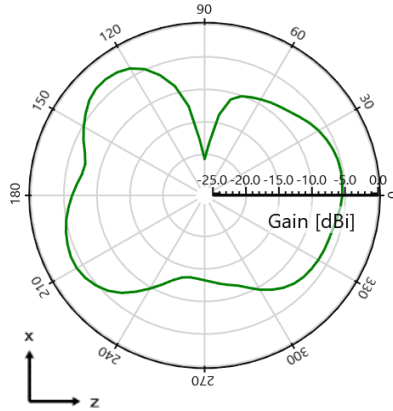
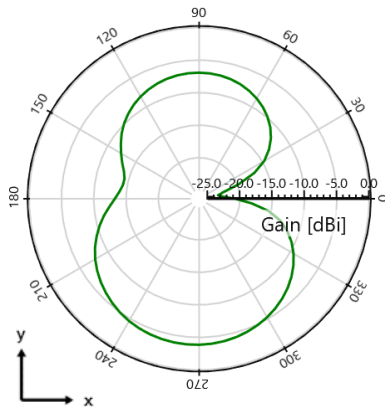

Measured at 450 MHz

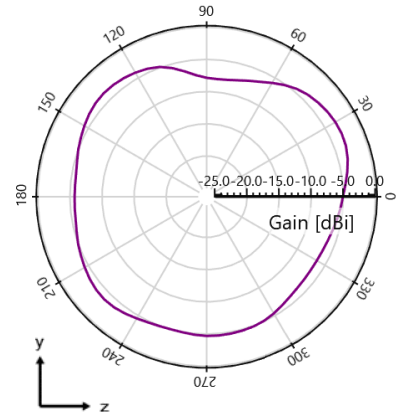
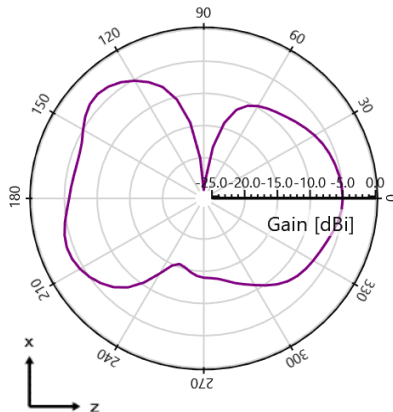
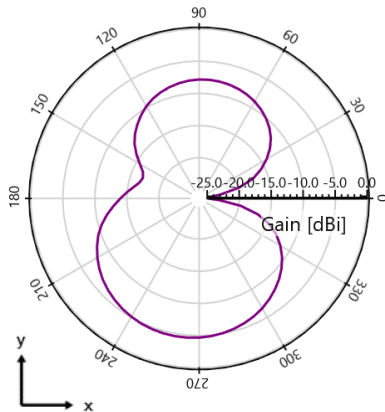

A1004795 / A1004796 Automotive Embedded 5G / LTE / NTN / GNSS KYOCERA AVX SMT Antenna Specifications.  
 KYOCERA AVX produces a wide variety of standard and custom antennas to meet user needs.

# Appendix 2

Appendix 2 gives instructions on how to achieve increased bandwidth to cover 600-960 MHz through impedance matching network.

(600-960 MHz)  
 (1710-2400 MHz)  
 (2500-2700 MHz)

Frequency (MHz)	600-698	698-960	1710-2400	2500-2700
Peak Gain	1.5 dBi	1.2 dBi	2.4 dBi	0.9 dBi
Average Efficiency	61%	55%	52%	48%
VSWR Match	< 5.5:1	< 3.7:1	< 2.5:1	< 3.0:1
Polarization	Linear			
Power Handling	2 Watt CW			
Feed Point Impedance	50 Ω unbalanced			

\*Data shown above has Appendix 2 matching applied on 125 x 45 mm pcb.

A1004795 / A1004796 Automotive Embedded 5G / LTE / NTN / GNSS KYOCERA AVX SMT Antenna Specifications.  
 KYOCERA AVX produces a wide variety of standard and custom antennas to meet user needs.

**Appendix 2: Antenna Matching Structure (A1004795)**

Typical matching values on 65 x 45 mm PCB

Demo Board Front View

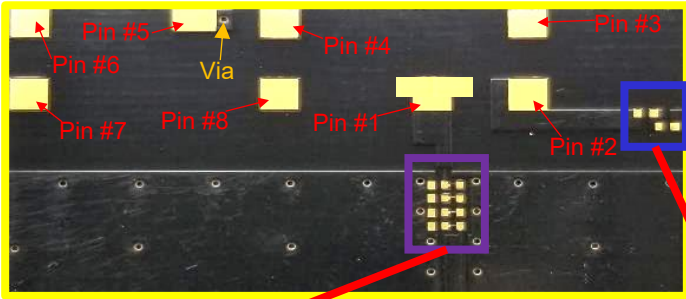

Demo Board Back View

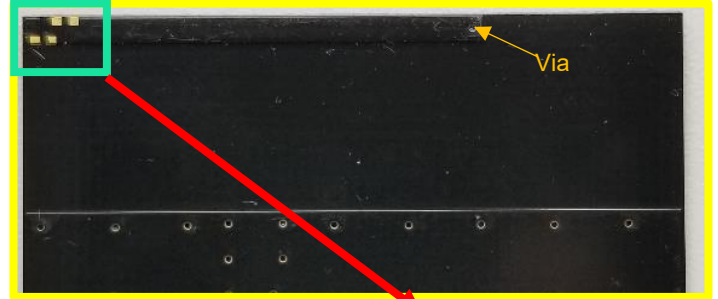

Antenna Matching

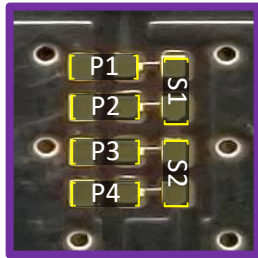

(Antenna Matching): pads are directly inline with the antenna feed trace.

2500-2700 MHz Tuning

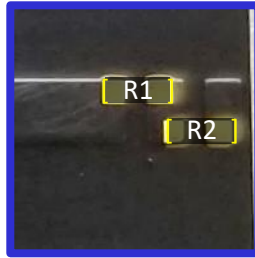

600-960 MHz & 1710-2400 MHz Tuning

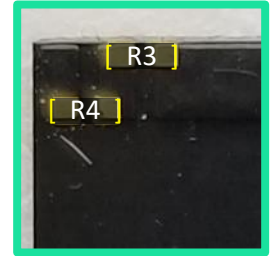

Pin Descriptions

Pin#	Description
1	Feed
2	Antenna Tuning
3	Dummy Pad
4	Dummy Pad
5	Antenna Tuning
6	Dummy Pad
7	Dummy Pad
8	Dummy Pad

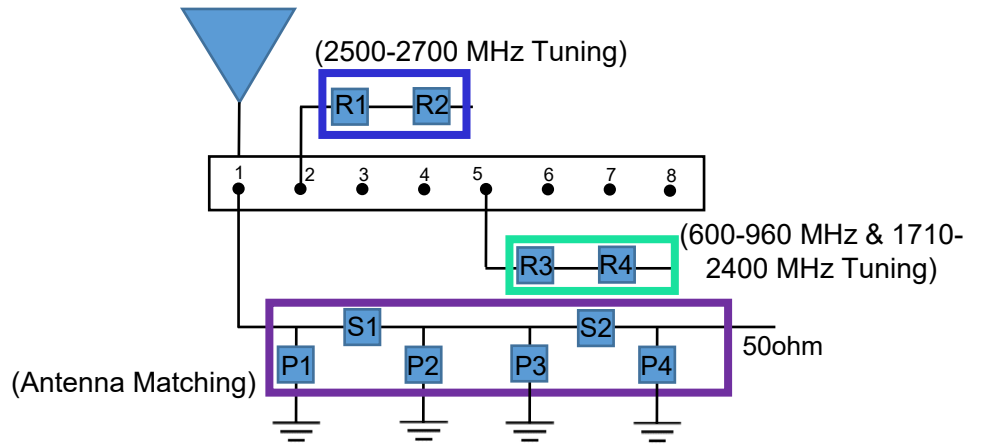

	P1	S1	P2	P3	S2	P4	R1	R2	R3-R4
<b>Default Matching</b>	8.2nH	4.7pF	0.3pF	N/A	0 Ohm	0.5pF	0 Ohm	N/A	0 Ohm
<b>Tolerance</b>	± 0.1nH	± 0.05pF	± 0.05pF	N/A	N/A	± 0.05pF	N/A	N/A	N/A

A1004795 / A1004796 Automotive Embedded 5G / LTE / NTN / GNSS KYOCERA AVX SMT Antenna Specifications.  
 KYOCERA AVX produces a wide variety of standard and custom antennas to meet user needs.

**Appendix 2: Antenna Tuning Options (A1004795)**

Typical matching values on 125 x 45 mm PCB

Demo Board Front View

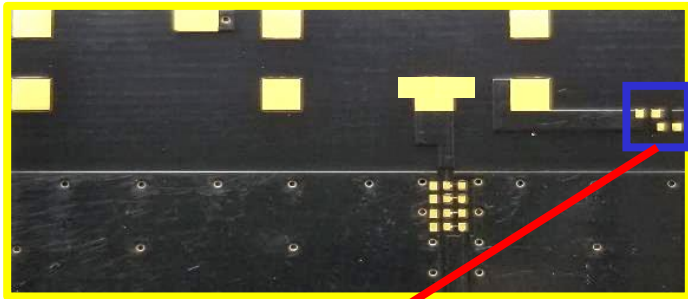

2500-2700 MHz Tuning

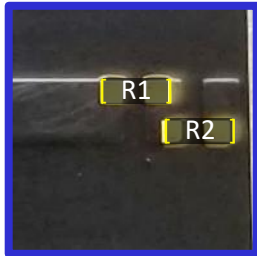

Demo Board Back View

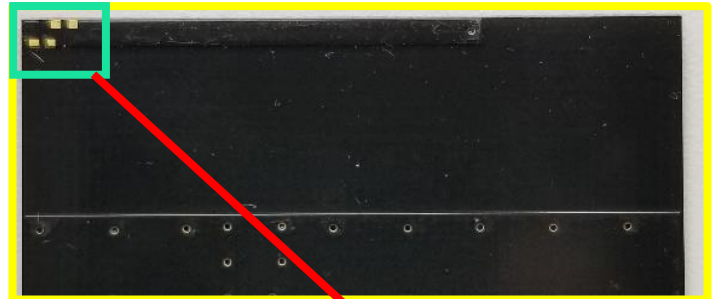

600-960 MHz  
& 1710-2400 MHz Tuning

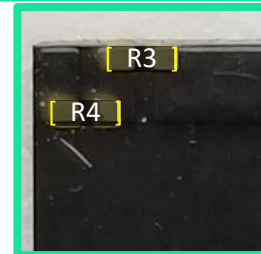

Options for Tuning: "600-960 MHz & 1710-2400 MHz"

MODE	T1	T2		T3	
PADS	Connect: R3 & R4	Remove: R4		Remove: R4 & R3	
Outcome: (Ref: Baseline)	BASELINE	(600-960 MHz) ~20 MHz shift high	(1710-2400 MHz) ~20 MHz shift high	(600-960 MHz) ~30 MHz shift high	(1710-2400 MHz) ~35 MHz shift high

\*R= 0 Ohm

Options for Tuning: "2500-2700 MHz"

MODE	T4	T5	T6
PADS	Connect: R1	Connect: R1 & R2	Remove: R1 & R2
Outcome: (Ref: Baseline)	BASELINE	~60 MHz shift low	~70 MHz shift high

\*R= 0 Ohm

A1004795 / A1004796 Automotive Embedded 5G / LTE / NTN / GNSS KYOCERA AVX SMT Antenna Specifications.  
 KYOCERA AVX produces a wide variety of standard and custom antennas to meet user needs.

## Appendix 2: VSWR and Efficiency Plots

Typical A1004795/A1004796 performance 125 x 45 mm PCB

**Low Band VSWR**

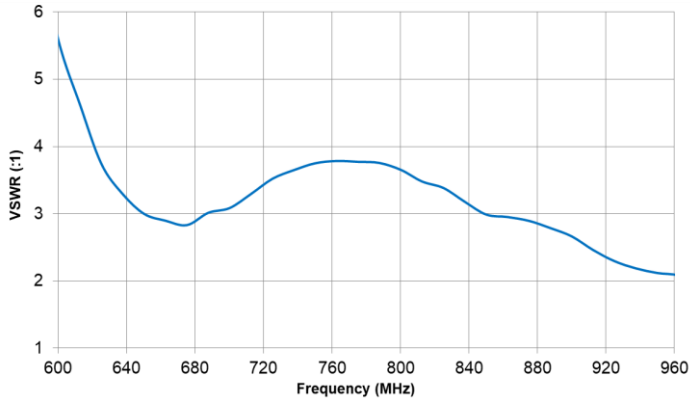

**Low Band Efficiency**

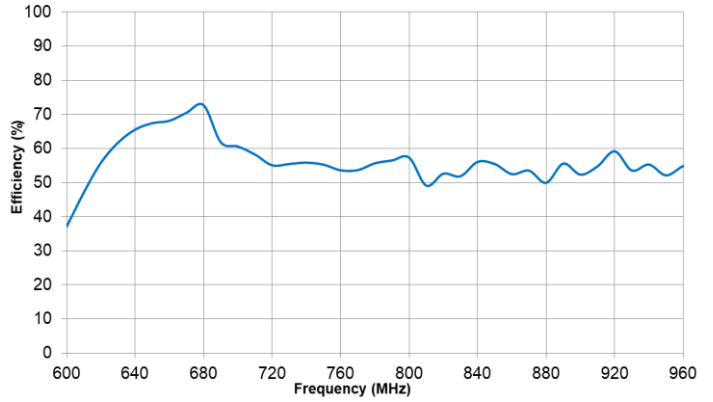

**High Band VSWR**

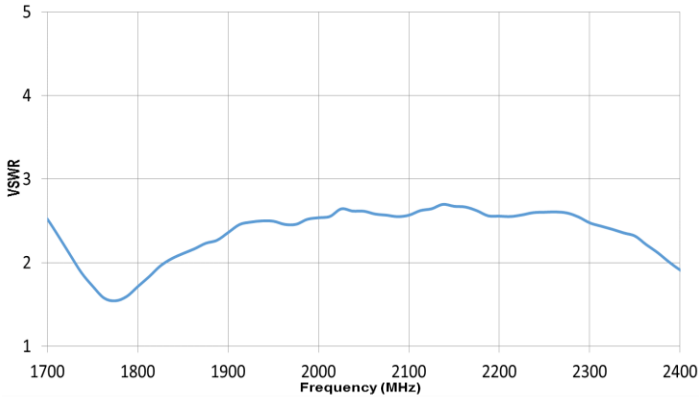

**High Band Efficiency**

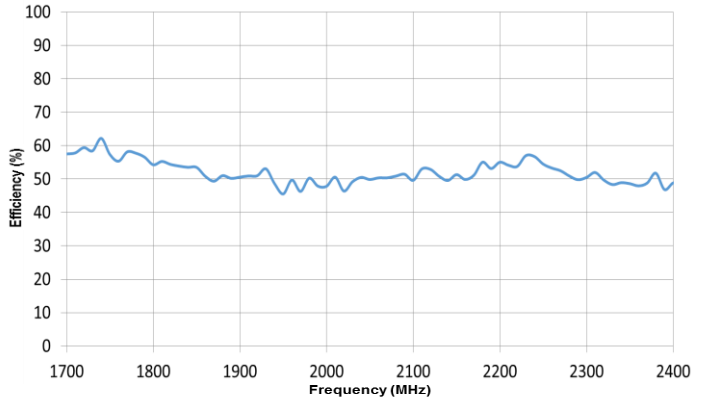

**Band 7 VSWR**

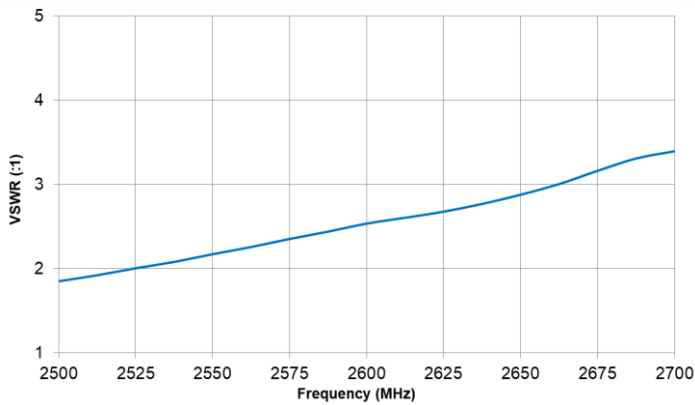

**Band 7 Efficiency**

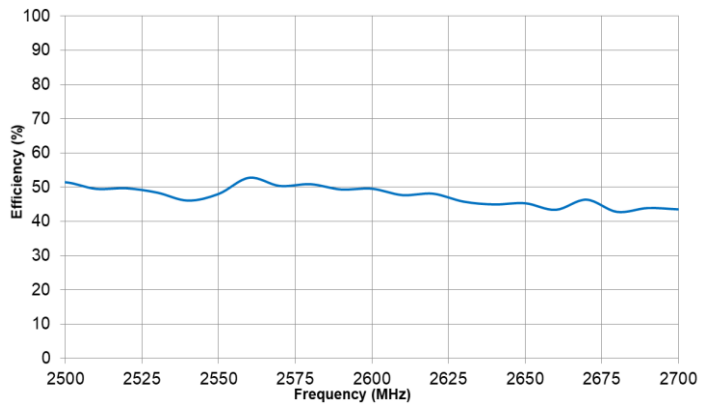

A1004795 / A1004796 Automotive Embedded 5G / LTE / NTN / GNSS KYOCERA AVX SMT Antenna Specifications.  
 KYOCERA AVX produces a wide variety of standard and custom antennas to meet user needs.

### Appendix 2: Antenna Radiation Patterns – Low / High Band

Typical A1004795/A1004796 performance 125 x 45 mm PCB

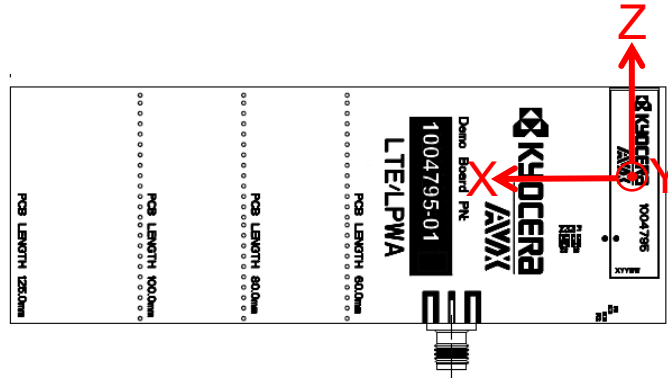

Low Band measured at  
600, 700 800, 900 MHz

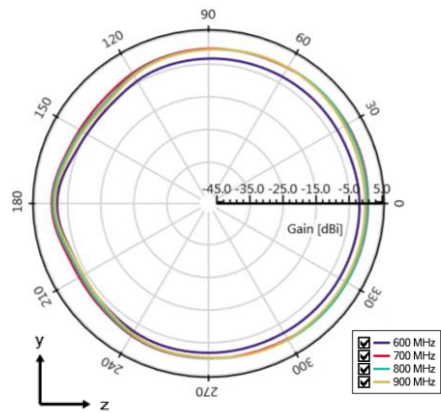
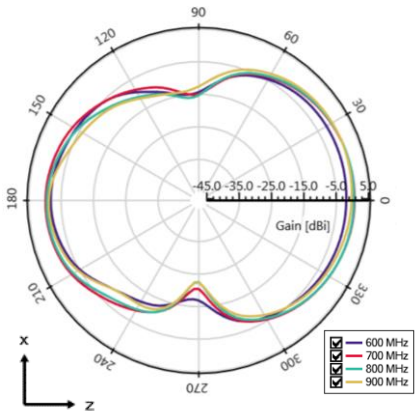
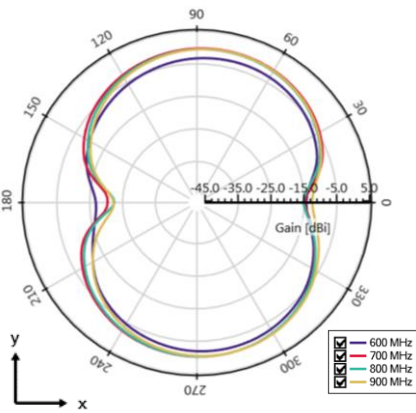

High Band measured at  
1800, 1900, 2100 MHz

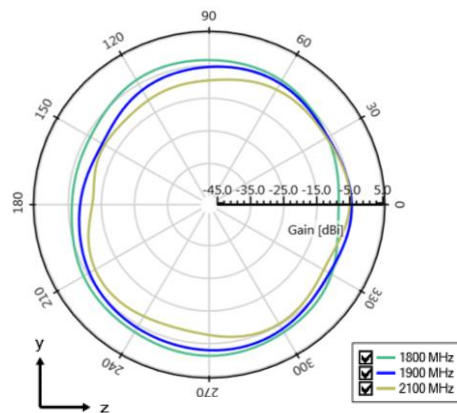
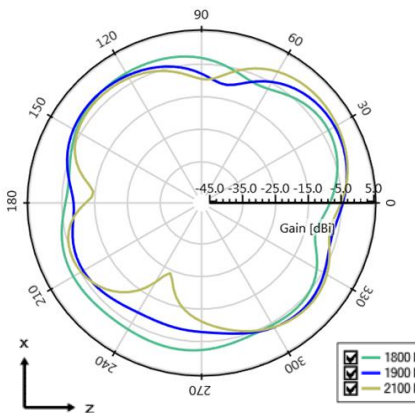
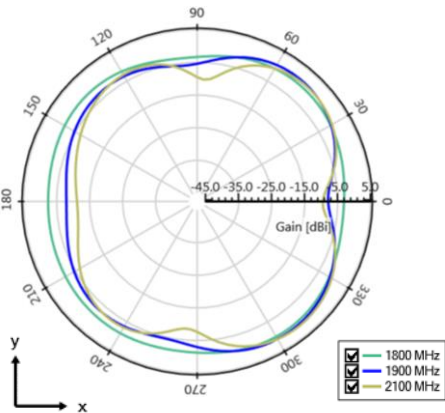

A1004795 / A1004796 Automotive Embedded 5G / LTE / NTN / GNSS KYOCERA AVX SMT Antenna Specifications.  
 KYOCERA AVX produces a wide variety of standard and custom antennas to meet user needs.

### Appendix 2: Antenna Radiation Patterns – High Band, Band 7

Typical A1004795/A1004796 performance 125 x 45 mm PCB

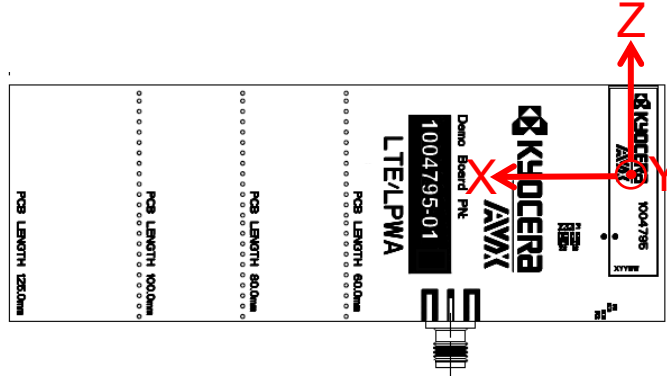

High Band measured at 2350 MHz

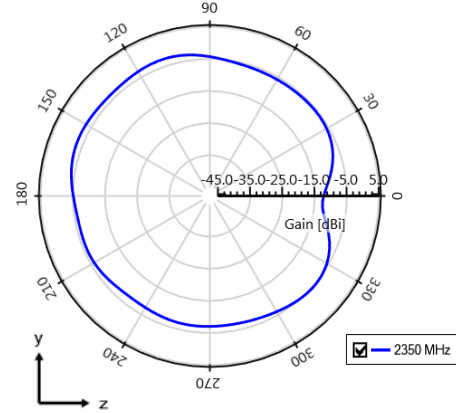
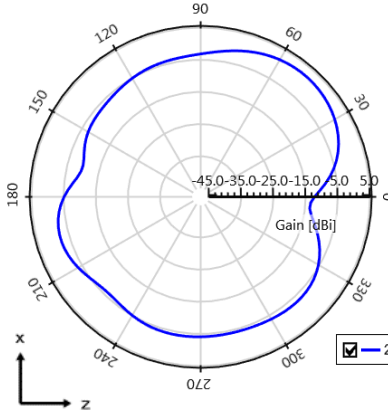
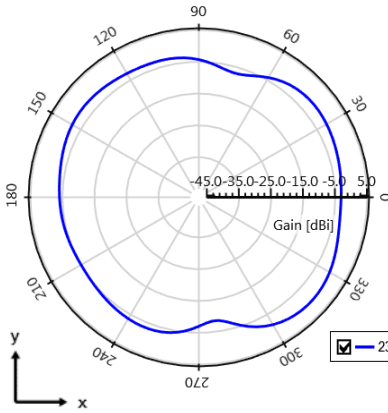

Band 7 measured at 2600 MHz

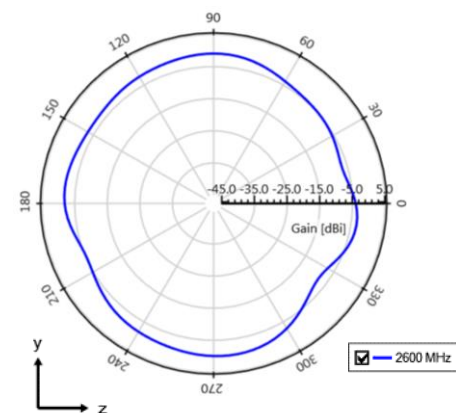
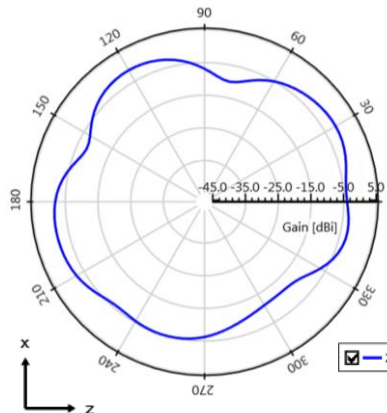
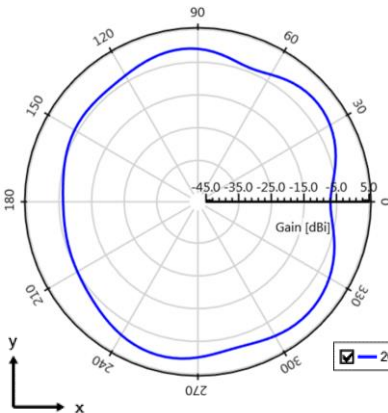

A1004795 / A1004796 Automotive Embedded 5G / LTE / NTN / GNSS KYOCERA AVX SMT Antenna Specifications.  
 KYOCERA AVX produces a wide variety of standard and custom antennas to meet user needs.

# Appendix 3

Appendix 3 gives instructions on how to achieve increased bandwidth to cover **Cellular 4G/5G, NTN and GNSS Bands** through impedance matching network **in a small PCB size.**

- (699 - 960 MHz, Cellular 4G/5G)
- (1710 - 2400 MHz, Cellular 4G/5G)
- (1525 - 1660 MHz, NTN L-Band)
- (1559 - 1610 MHz, GNSS)
- (1980 - 2200 MHz, NTN S-Band)
- (2500-2700 MHz, Cellular 4G/5G)

Frequency (MHz)	699-960	1710-2400	1525-1660	1559-1610	1980-2200	2500-2700
Peak Gain	- 1.4 dBi	2.5 dBi	0.5 dBi	0.1 dBi	2.5 dBi	2 dBi
Average Efficiency	23 %	66 %	50 %	50 %	65 %	48 %
Return Loss Match	< - 3.7	< - 10	< - 6	< - 6.5	< - 9.5	< - 6
Polarization	Linear					
Power Handling	2 Watt CW					
Feed Point Impedance	50 Ω unbalanced					
Radiation Pattern	Omni-directional					

\*Data shown above has Appendix 3 matching applied on 60 x 45 mm PCB.

A1004795 / A1004796 Automotive Embedded 5G / LTE / NTN / GNSS KYOCERA AVX SMT Antenna Specifications.  
 KYOCERA AVX produces a wide variety of standard and custom antennas to meet user needs.

### Appendix 3: Antenna Matching Structure (A1004795)

Typical matching values on 60 x 45 mm PCB

\*Also applies to mirrored layout A1004796

Demo Board Front View

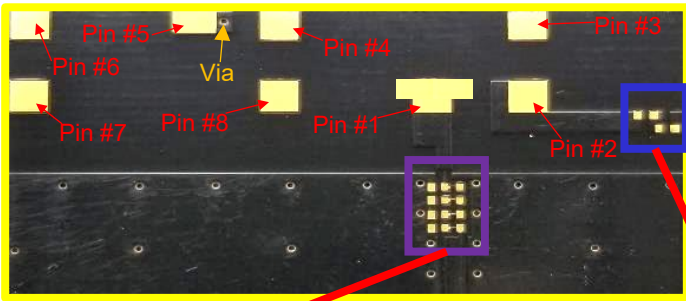

Demo Board Back View

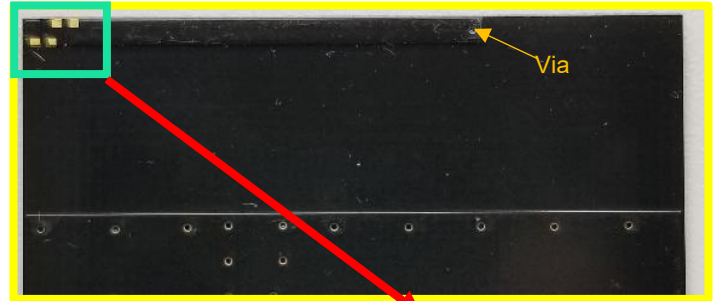

Antenna Matching

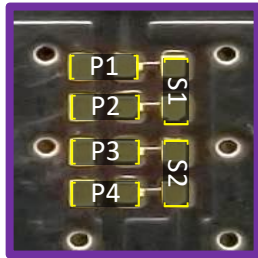

(Antenna Matching): pads are directly inline with the antenna feed trace.

2500-2700 MHz Tuning

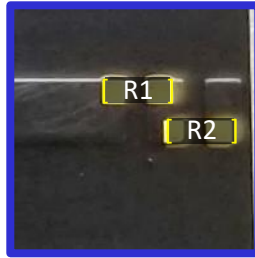

700-960 MHz & 1710-2400 MHz Tuning



#### Pin Descriptions

Pin#	Description
1	Feed
2	Antenna Tuning
3	Dummy Pad
4	Dummy Pad
5	Antenna Tuning
6	Dummy Pad
7	Dummy Pad
8	Dummy Pad

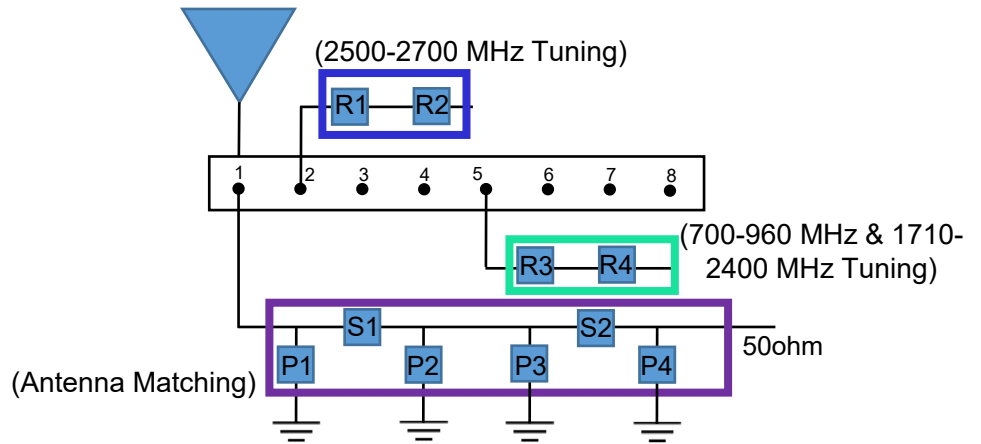

	P1	S1	P2	P3	S2	P4	R1	R2	R3-R4
<b>Default Matching</b>	8.2nH	4.7pF	0.3pF	N/A	0 Ohm	0.5pF	0 Ohm	N/A	0 Ohm
<b>Tolerance</b>	± 0.1nH	± 0.05pF	± 0.05pF	N/A	N/A	± 0.05pF	N/A	N/A	N/A

A1004795 / A1004796 Automotive Embedded 5G / LTE / NTN / GNSS KYOCERA AVX SMT Antenna Specifications.  
 KYOCERA AVX produces a wide variety of standard and custom antennas to meet user needs.

### Appendix 3: Return Loss Data

Typical A1004795/A1004796 performance 60 x 45 mm PCB

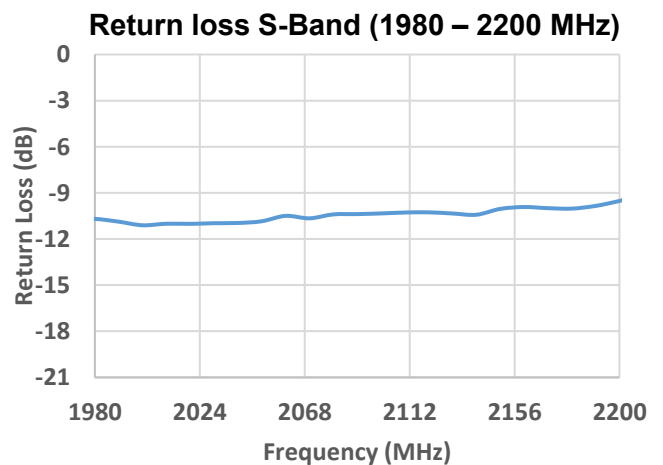
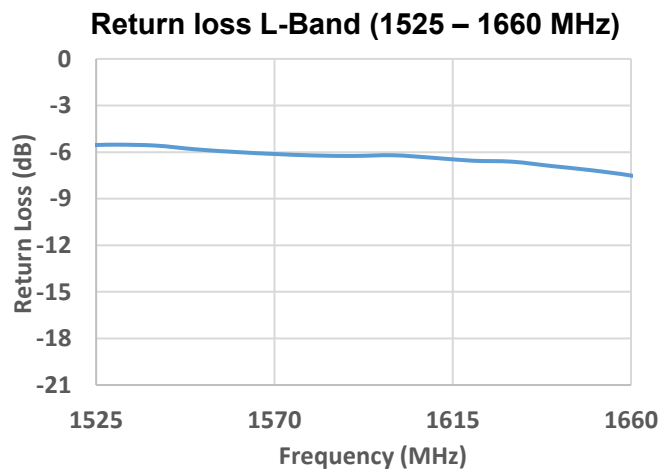
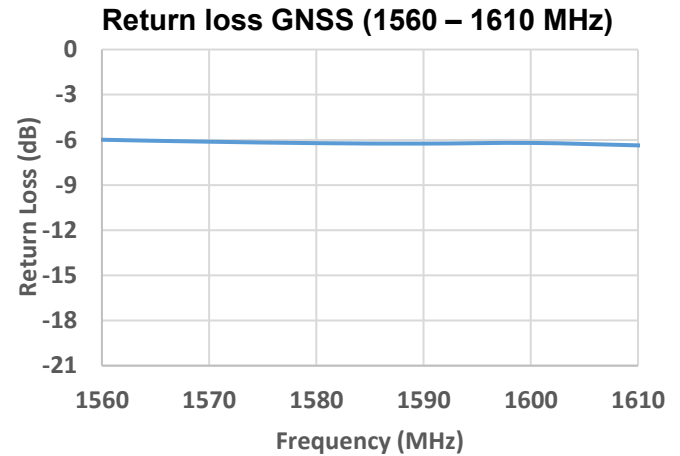
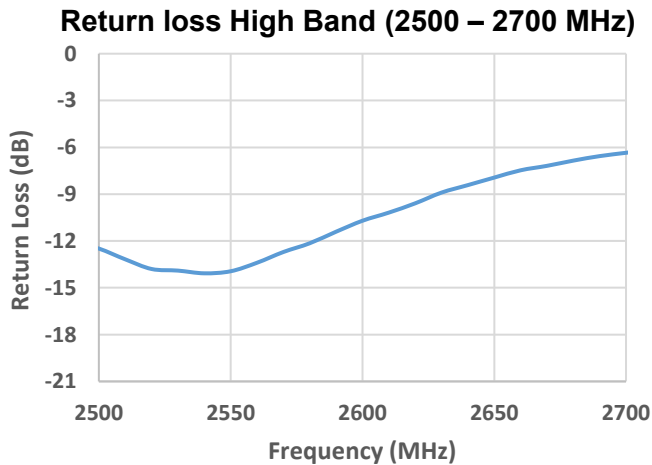
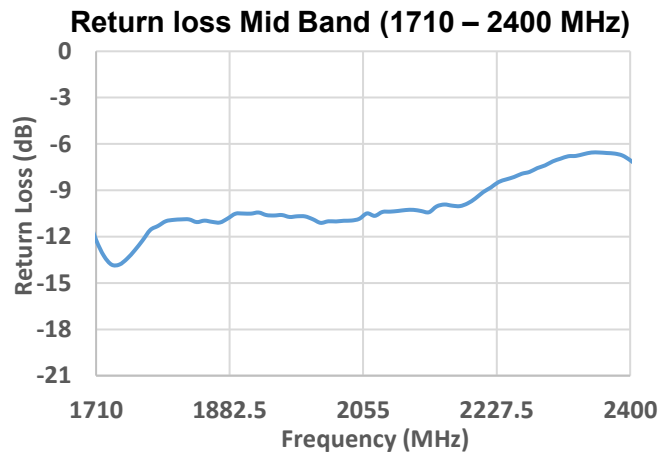
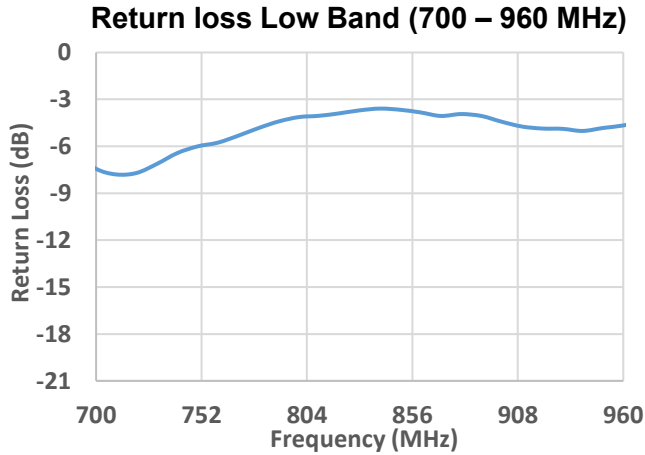

A1004795 / A1004796 Automotive Embedded 5G / LTE / NTN / GNSS KYOCERA AVX SMT Antenna Specifications.  
 KYOCERA AVX produces a wide variety of standard and custom antennas to meet user needs.

### Appendix 3: Efficiency Data

Typical A1004795/A1004796 performance 60 x 45 mm PCB

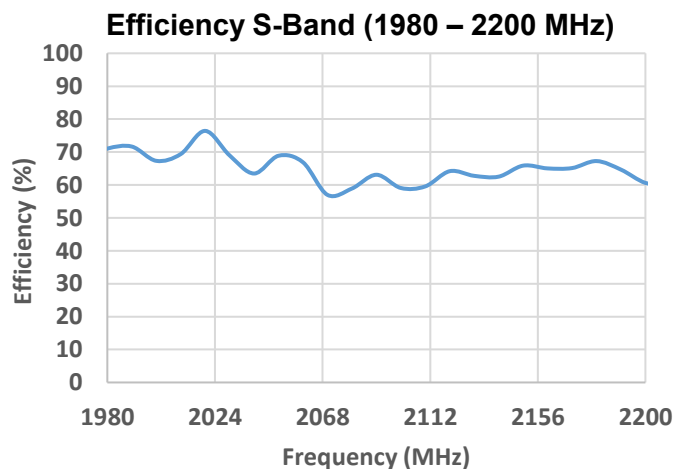
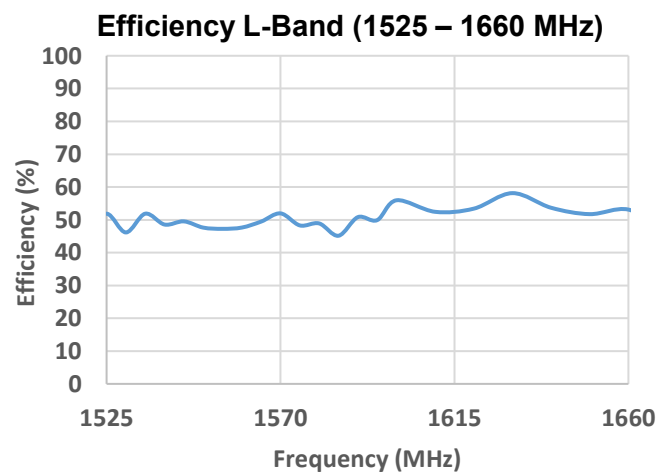
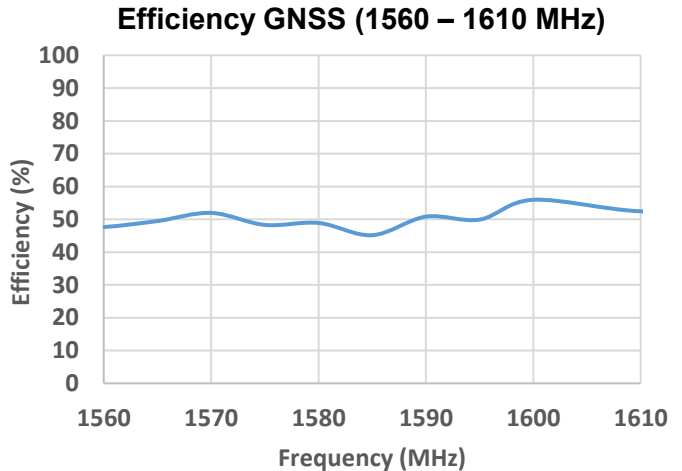
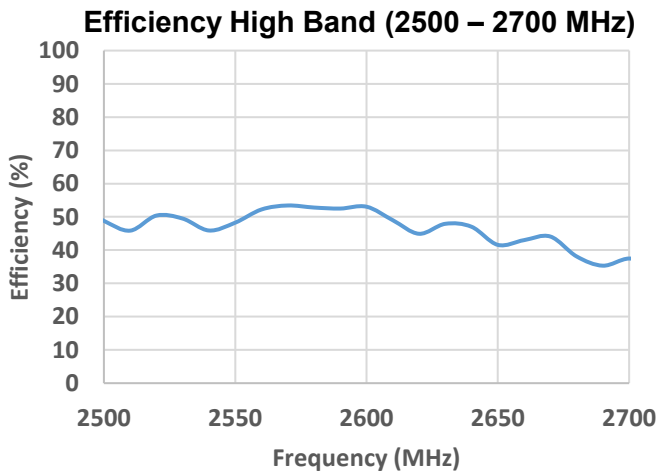
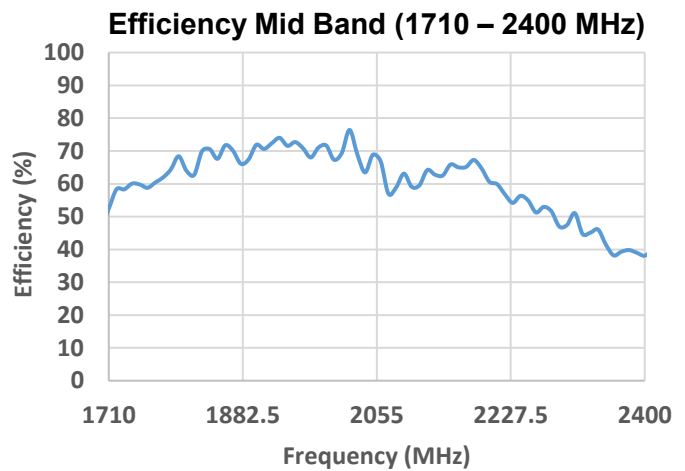
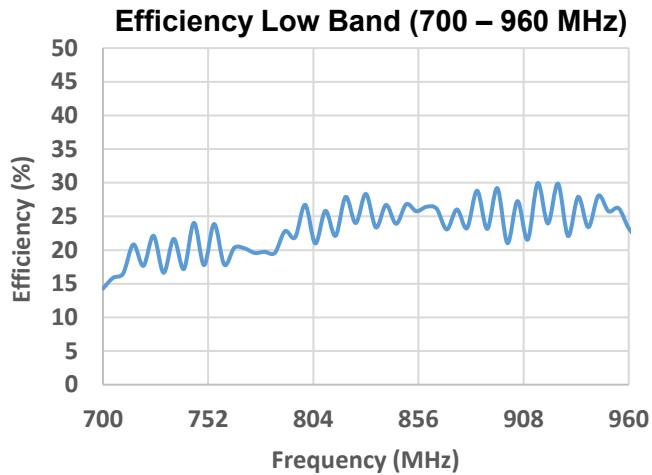

A1004795 / A1004796 Automotive Embedded 5G / LTE / NTN / GNSS KYOCERA AVX SMT Antenna Specifications.  
 KYOCERA AVX produces a wide variety of standard and custom antennas to meet user needs.

### Appendix 3: Peak Gain Data

Typical A1004795/A1004796 performance 60 x 45 mm PCB

**Peak Gain Low Band (700 – 960 MHz)**

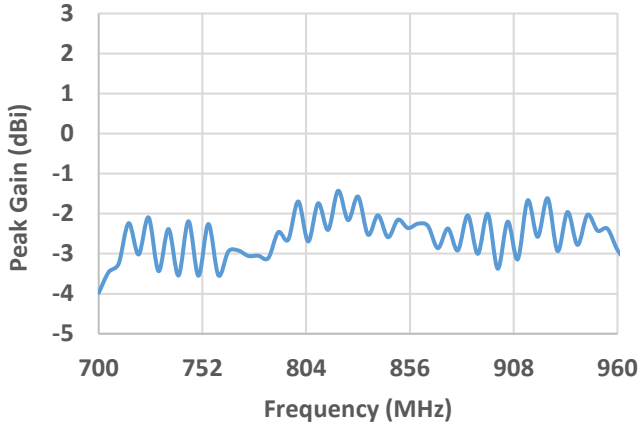

**Peak Gain Mid Band (1710 – 2400 MHz)**

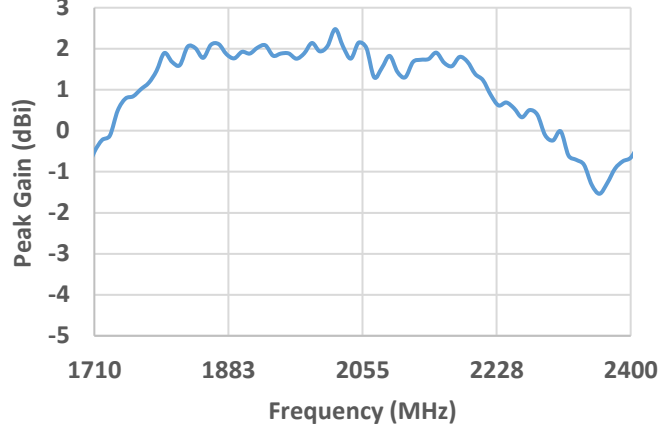

**Peak Gain High Band (2500 – 2700 MHz)**

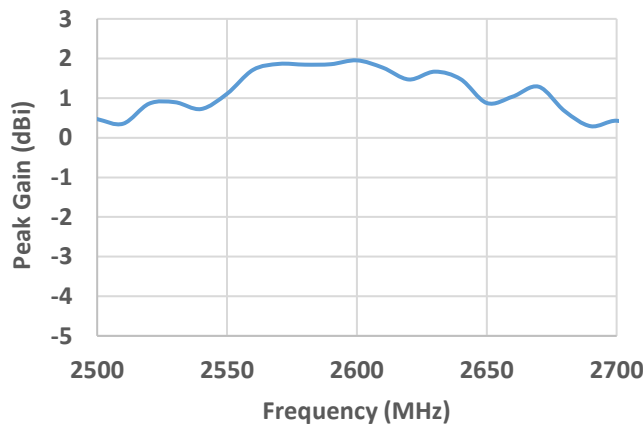

**Peak Gain GNSS (1560 – 1610 MHz)**

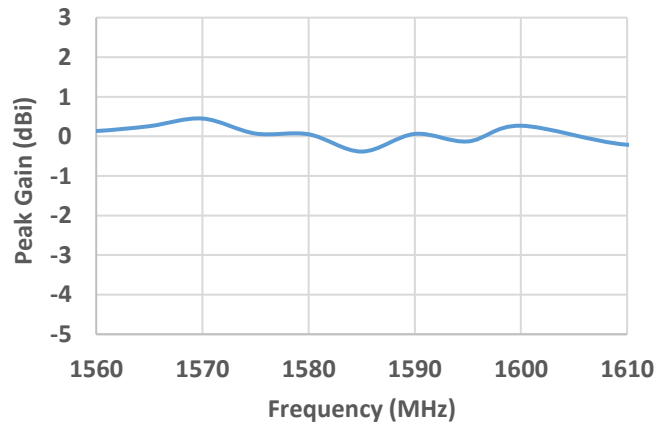

**Peak Gain L-Band (1525 – 1660 MHz)**

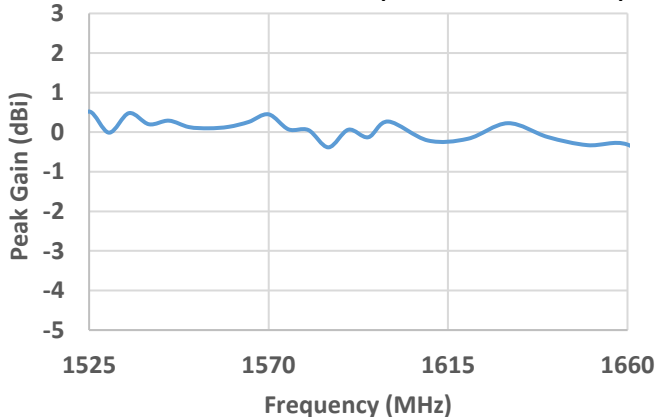

**Peak Gain S-Band (1980 – 2200 MHz)**

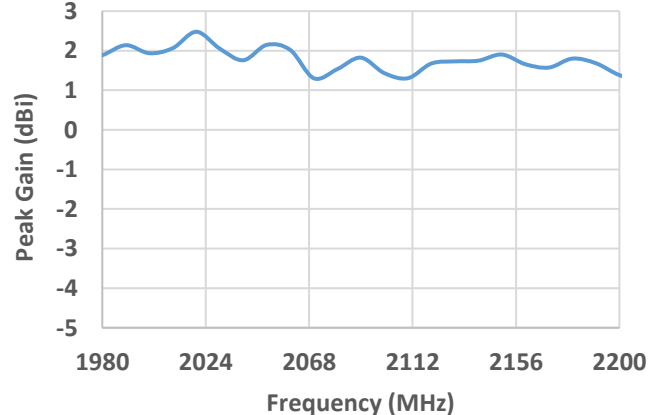

A1004795 / A1004796 Automotive Embedded 5G / LTE / NTN / GNSS KYOCERA AVX SMT Antenna Specifications.  
 KYOCERA AVX produces a wide variety of standard and custom antennas to meet user needs.

### Appendix 3: Antenna Radiation Patterns

Typical A1004795/A1004796 performance 60 x 45 mm PCB

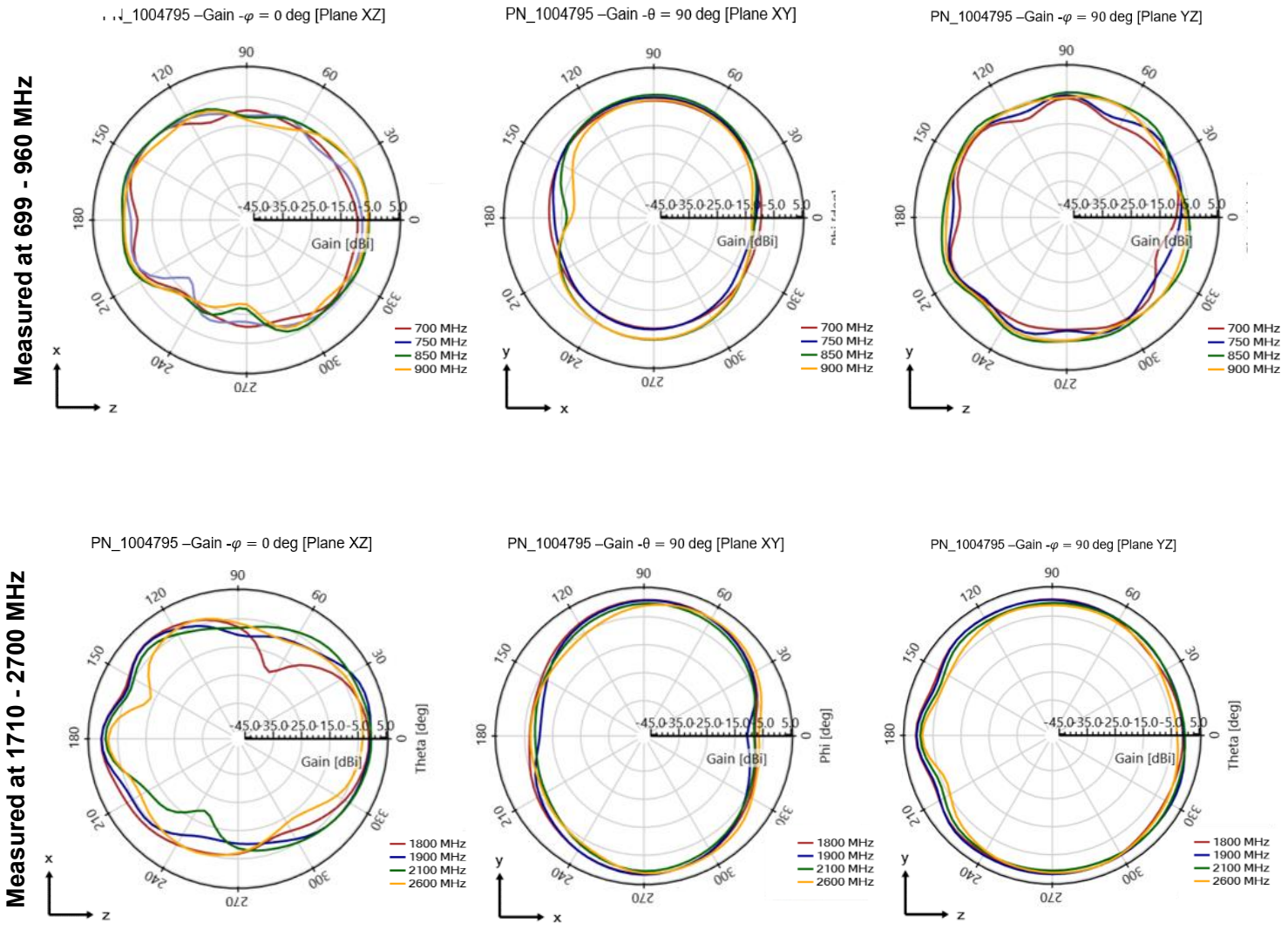
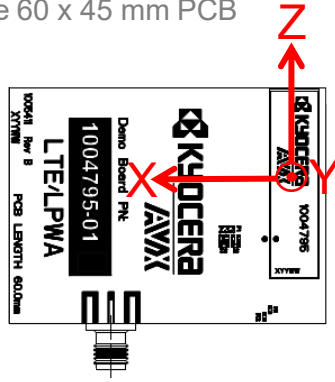

A1004795 / A1004796 Automotive Embedded 5G / LTE / NTN / GNSS KYOCERA AVX SMT Antenna Specifications.  
 KYOCERA AVX produces a wide variety of standard and custom antennas to meet user needs.

### Appendix 3: Antenna Radiation Patterns

Typical A1004795/A1004796 performance 60 x 45 mm PCB

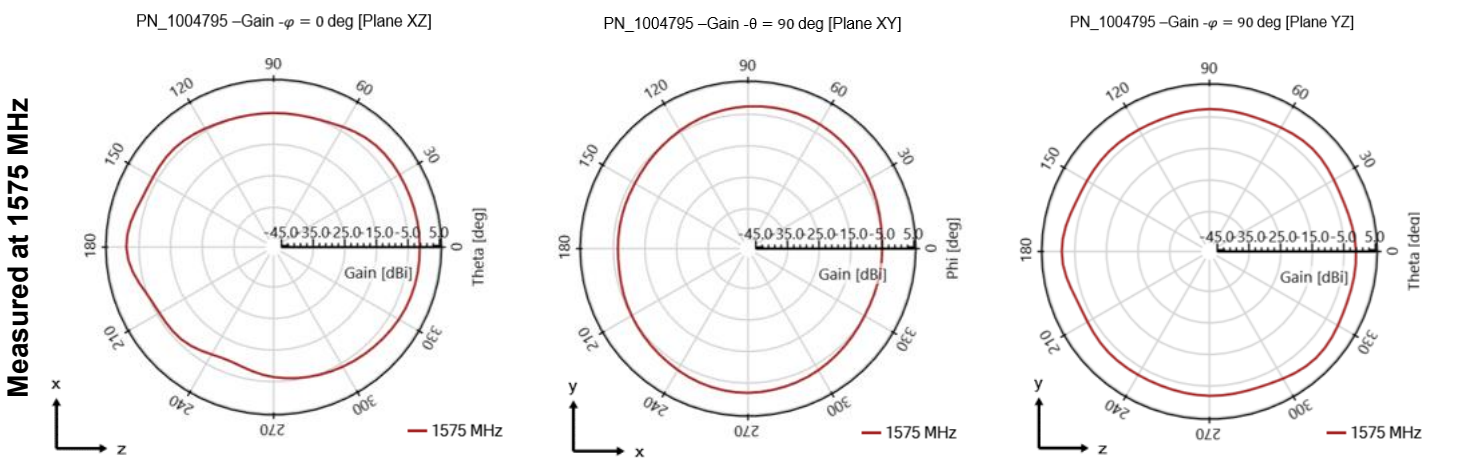
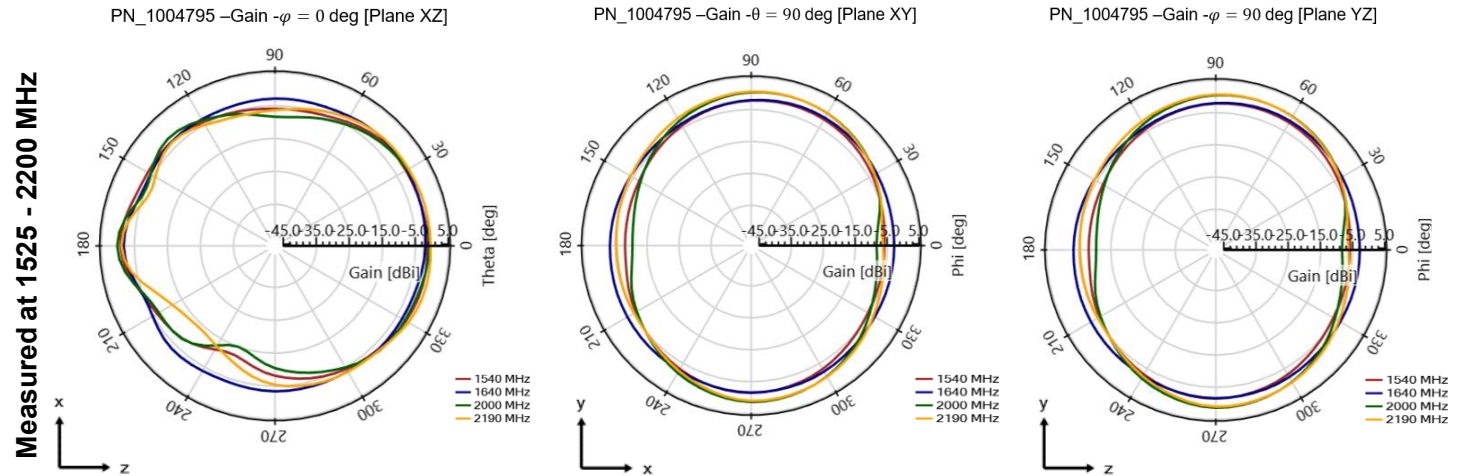
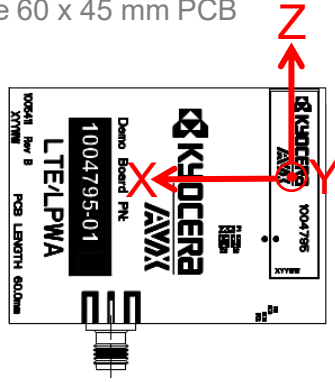

A1004795 / A1004796 Automotive Embedded 5G / LTE / NTN / GNSS KYOCERA AVX SMT Antenna Specifications.  
 KYOCERA AVX produces a wide variety of standard and custom antennas to meet user needs.

### Recommended Reflow Soldering Profile

The recommended method for soldering the antenna to the board is forced convection reflow soldering. The following suggestions provide information on how to optimize the reflow process for the FR4 antenna:

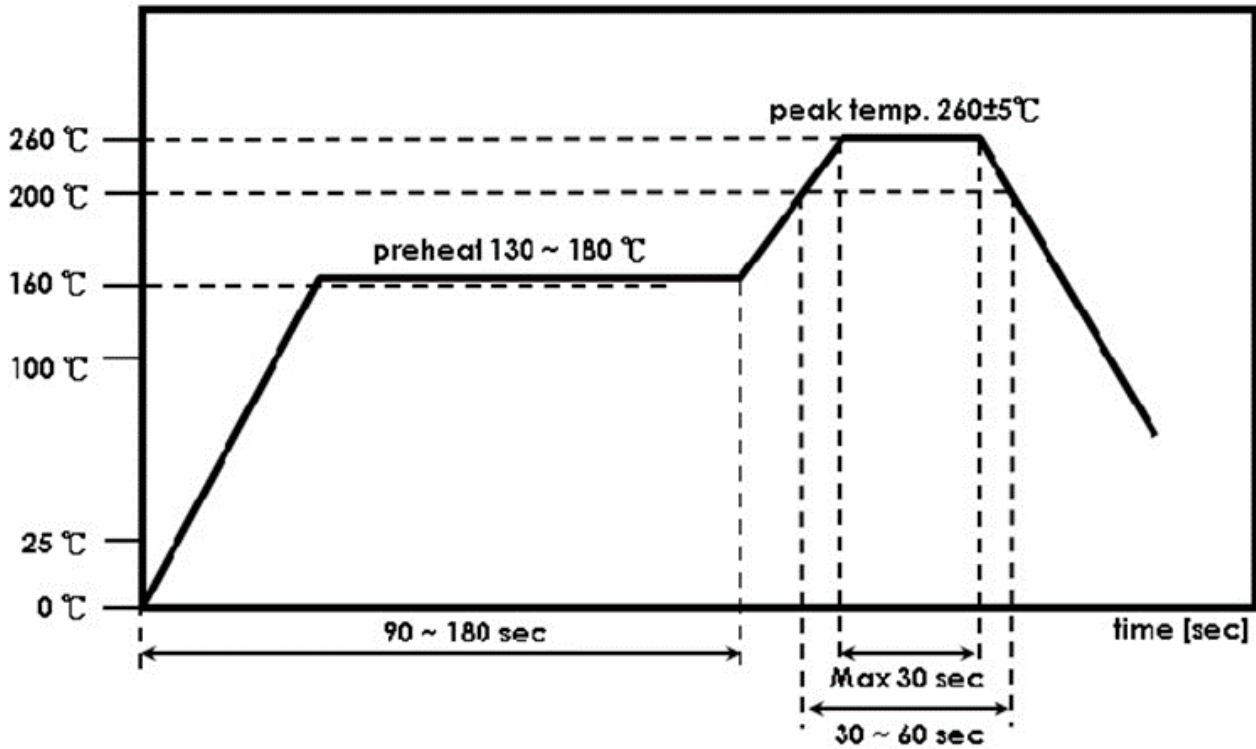

\*Adjust the reflow duration to create good solder joints without raising the antenna temperature beyond the allowed maximum of 260° C.

A1004795 / A1004796 Automotive Embedded 5G / LTE / NTN / GNSS KYOCERA AVX SMT Antenna Specifications.  
KYOCERA AVX produces a wide variety of standard and custom antennas to meet user needs.

### Additional Resources A1004795 - LTE/ NTN PCB Antenna with SMA Connector

**3D FIT File:**

[https://www.kyocera-avx.com/download/antennas/ME-FIT/1004795\\_ME\\_fit.zip](https://www.kyocera-avx.com/download/antennas/ME-FIT/1004795_ME_fit.zip)

**DXF File:**

[https://www.kyocera-avx.com/download/antennas/3D-DXF/1004795\\_3D-DXF.zip](https://www.kyocera-avx.com/download/antennas/3D-DXF/1004795_3D-DXF.zip)

**Gerber File:**

[https://www.kyocera-avx.com/download/antennas/GERBER/1004795\\_GERBERS.zip](https://www.kyocera-avx.com/download/antennas/GERBER/1004795_GERBERS.zip)