

Linking Contact System: 70-9159 BTB

General Description

STRIPT™ or naked contacts have been proven to provide high performance at a lower cost structure than traditional insulated connectors. Adding to the list of UL certified contacts already on the market from KYOCERA AVX, the new high spring force “C-Clip” designed SMT contact can be linked together with a bridging contact to provide ultra-reliability in linear BTB connections. In addition to robustness, this three-piece component set absorbs mating tolerances between the boards and can handle 20 amps of continuous current.

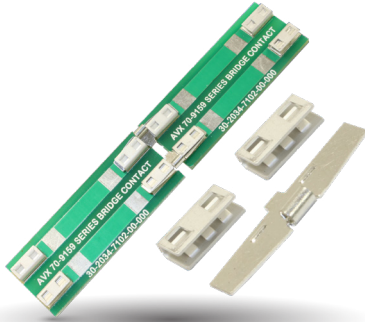

APPLICATIONS

- Linear LED Board-to-Board connections
- Co-Planar PCB mating

FEATURES AND BENEFITS

- Fatigue resistant phosphor bronze material which generates and maintains high mating forces
- Integral dimples on the bridge contact provides positive retention in the c-clip contact
- Center placed attachment tang prevents the bridge contact from moving forward or backwards

ELECTRICAL

- Current Rating: 9 Amps
- Voltage Rating: 300V

ENVIRONMENTAL

- Operating Temperature: -40°C to +125°C

MECHANICAL

- Contact Material: Phosphor Bronze
- Plating: Lead-Free Matte Tin Over Nickel
- Durability: 5 Cycles

HOW TO ORDER

70	9159	001	3XX	006
Prefix	Series	Number of Ways 001 = 1	Contact Description 302 = SMT Contact 311 = Bridge Contact	Plating Option 006 = Tin Over Nickel

Linking Contact System: 70-9159 BTB

Low Profile High Current & Bridge Contact

LOW PROFILE HIGH CURRENT SURFACE MOUNT CONTACT

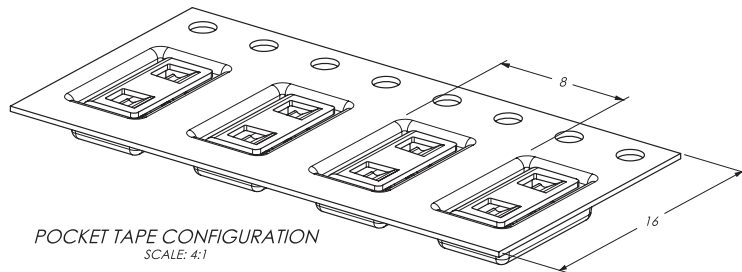

POCKET TAPE CONFIGURATION
SCALE: 4:1

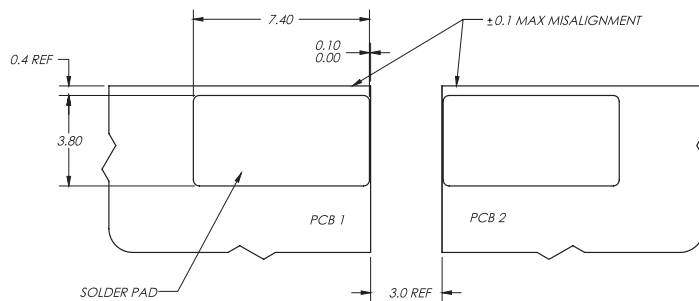
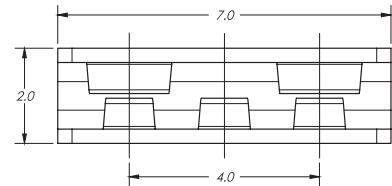
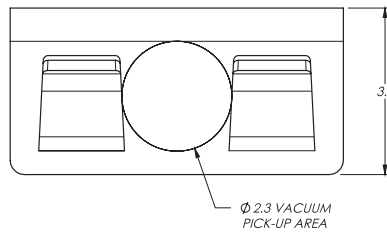
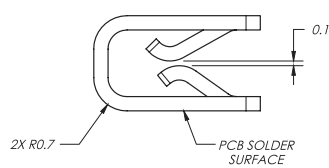
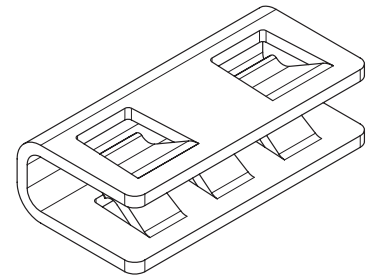

PCB LAYOUT AND ARRANGEMENT
SCALE: 5:1

BRIDGE CONTACT 9159 SERIES SPECIAL

