

Thin-Film RF/Microwave Inductor Technology

Accu-L® Series

AEC-Q200 High-Q RF Inductor - L0402 & L0805

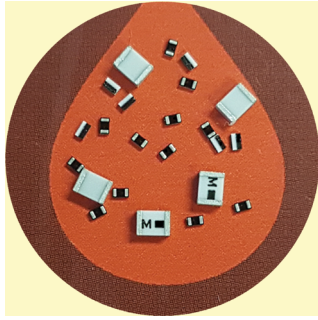

ACCU-L® TECHNOLOGY

The L0402 LGA Inductor and the L0805 Accu-L® SMD Inductor are based on thin-film multilayer technology. This technology provides a level of control on the electrical and physical characteristics of the component which gives consistent characteristics within a lot and lot-to-lot. The original design provides small size, excellent high-frequency performance and rugged construction for reliable automatic assembly.

The AEC-Q200 Qualified Accu-L® Series is designed to meet the demanding performance specifications in automotive signal and power applications.

FEATURES

- High Q
- RF Power Capability
- High SRF
- Low DC Resistance
- Ultra-Tight Inductance Tolerance
- Standard 0402 and 0805 Chip Sizes
- Low Profile
- Rugged Construction
- Taped and Reeled
- Operating/Storage Temp. Range: -55°C to +125°C

APPLICATIONS

- Vehicle to Vehicle Communications
- Infotainment
- Telematics
- GPS
- Radar
- Vehicle Locations Systems
- Keyless Entry
- Filters
- Matching Networks

0402 DIMENSIONS: millimeters (inches) (Bottom View)

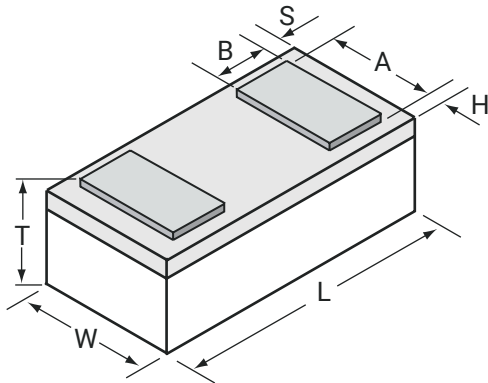

L	1.00±0.10 (0.039±0.004)
W	0.58±0.07 (0.023±0.003)
T	0.35±0.10 (0.014±0.004)
A	0.48±0.05 (0.019±0.002)
B	0.17±0.05 (0.007±0.002)
S, H	0.064±0.05 (0.003±0.002)

0805 DIMENSIONS: millimeters (inches)

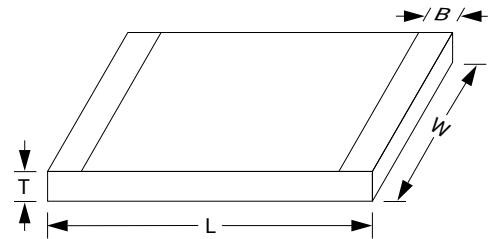

L	2.11±0.10 (0.083±0.004)
W	1.5±0.10 (0.059±0.004)
T	.91±0.13 (0.036±0.005)
B	0.25±0.15 (0.010±0.006)

Thin-Film RF/Microwave Inductor Technology



Accu-L® Series

AEC-Q200 High-Q RF Inductor - L0402 & L0805

HOW TO ORDER

L ↓	0805 ↓	4R7 ↓	D ↓	4 ↓	S ↓	TR ↓
Product Inductor	Size 0402 0805	Inductance Expressed in nH (2 significant digits + number of zeros) for values <10nH, letter R denotes decimal point. Example: 22nH = 220 4.7nH = 4R7	Tolerance A = ±0.05nH B = ±0.1nH C = ±0.2nH D = ±0.5nH G = ±2% J = ±5%	Specification Code 4 = AEC-Q200 Qualified Accu-L®	Termination Code S = Nickel/ Sn100 Lead Free Solder coated (L0805) N=Nickel/ Sn100 Lead Free Solder coated (L0402)	Packaging Code TR = Tape & Reel



ELECTRICAL SPECIFICATIONS TABLE FOR ACCU-L® 0402

L(nH)	450MHz		Q (Typ)	Q (Typ)	900MHz (Typ)	1900MHz (Typ)	2400MHz (Typ)	SRF min (MHz)	R _{DC} max. (Ω)	I _{DC} max. (mA)
	Tolerance	Q (min)								
0.56	A=±0.05nH, B=±0.1nH, C=±0.2nH, D=±0.5nH	35	45	55	65	75	20000	0.02	1000	
0.68	±0.05nH, ±0.1nH	30	40	50	60	70	20000	0.04	750	
0.82	±0.05nH, ±0.1nH	25	40	50	60	70	20000	0.06	500	
1.0	±0.05nH, ±0.1nH	20	30	35	40	50	20000	0.15	500	
1.2	±0.05nH, ±0.1nH, ±0.2nH	20	30	30	40	45	20000	0.20	400	
1.5	±0.05nH, ±0.1nH, ±0.2nH	20	25	30	40	40	18000	0.20	400	
1.8	±0.05nH, ±0.1nH, ±0.2nH	18	20	30	35	40	16000	0.20	400	
2.2	±0.05nH, ±0.1nH, ±0.2nH	15	20	25	35	40	15000	0.20	400	
2.7	±0.05nH, ±0.1nH, ±0.2nH	15	20	25	35	40	9500	0.25	250	
3.3	±0.1nH, ±0.2nH, ±0.5nH	15	20	25	35	40	8500	0.40	250	
3.9	±0.1nH, ±0.2nH, ±0.5nH	13	20	20	30	30	8000	0.45	250	
4.7	±0.1nH, ±0.2nH, ±0.5nH	13	20	20	30	30	7500	0.45	250	
5.6	±0.1nH, ±0.2nH, ±0.5nH	13	20	20	30	30	7000	0.65	200	
6.8	±0.1nH, ±0.2nH, ±0.5nH	12	15	20	25	30	6500	0.90	200	

Please contact factory for intermediate inductance values within the indicated range.

ELECTRICAL SPECIFICATIONS TABLE FOR ACCU-L® 0805

Inductance L(nH)	450MHz Test Frequency		900MHz Test Frequency		1900MHz Test Frequency		2400MHz Test Frequency		SRF min (MHz)	R _{DC} max. (Ω)	I _{DC} max. (mA)	
	Available Inductance Tolerance	Q Typical	L (nH)	Q Typical	L (nH)	Q (Typ)	L (nH)	Q (Typ)			ΔT = 15°C (1)	ΔT = 70°C (2)
1.2	±0.1nH, ±0.2nH, ±0.5nH	60	1.2	92	1.2	122	1.2	92	10000	0.05	1000	2000
1.5	±0.1nH, ±0.2nH, ±0.5nH	50	1.5	74	1.5	102	1.5	84	10000	0.05	1000	2000
1.8	±0.1nH, ±0.2nH, ±0.5nH	50	1.8	72	1.8	88	1.9	73	10000	0.06	1000	2000
2.2	±0.1nH, ±0.2nH, ±0.5nH	42	2.2	62	2.2	82	2.3	72	10000	0.07	1000	2000
2.7	±0.1nH, ±0.2nH, ±0.5nH	42	2.7	62	2.8	80	2.9	70	10000	0.08	1000	2000
3.3	±0.1nH, ±0.2nH, ±0.5nH	38	3.3	46	3.4	48	3.5	57	10000	0.11	750	1500
3.9	±0.1nH, ±0.2nH, ±0.5nH	27	3.9	36	4.0	38	4.1	42	10000	0.20	750	1500
4.7	±0.1nH, ±0.2nH, ±0.5nH	43	4.8	62	5.3	76	5.8	60	5500	0.10	750	1500
5.6	±0.5nH	50	5.7	68	6.3	73	7.6	62	4600	0.10	750	1500
6.8	±0.5nH	43	7.0	62	7.7	71	9.4	50	4500	0.11	750	1500
8.2	±0.5nH	43	8.5	56	10.0	55	15.2	32	3500	0.12	750	1500
10	±2%, ±5%	46	10.6	60	13.4	52	-	-	2500	0.13	750	1500
12	±2%, ±5%	40	12.9	50	17.3	40	-	-	2400	0.20	750	1500
15	±2%, ±5%	36	16.7	46	27	23	-	-	2200	0.20	750	1000
18	±2%, ±5%	30	21.9	27	-	-	-	-	1700	0.35	500	1000
22	±2%, ±5%	36	27.5	33	-	-	-	-	1400	0.40	500	1000

(1) I_{DC} measured for 15°C rise at 25°C ambient temperature
 (2) I_{DC} measured for 70°C rise at 25°C ambient temperature

L, Q, SRF measured on HP 4291A, Boonton 34A and Wiltron 360 Vector Analyzer, RDC measured on Keithley 580 micro-ohmmeter.



The Important Information/Disclaimer is incorporated in the catalog where these specifications came from or available online at www.kyocera-avx.com/disclaimer/ by reference and should be reviewed in full before placing any order.

Typical Q vs. Frequency
L0805

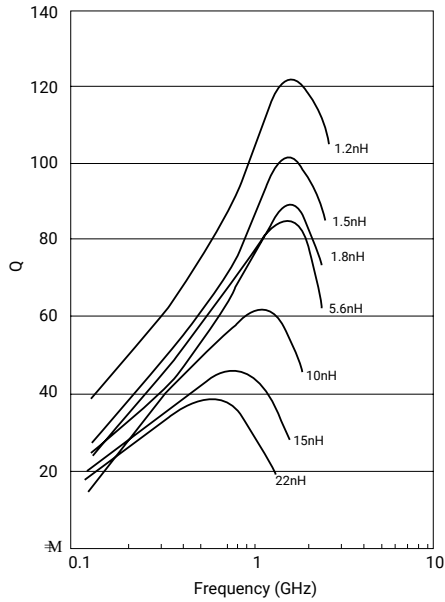

Measured on HP4291A and
Boonton 34A Coaxial Line

Typical Inductance vs. Frequency
L0805

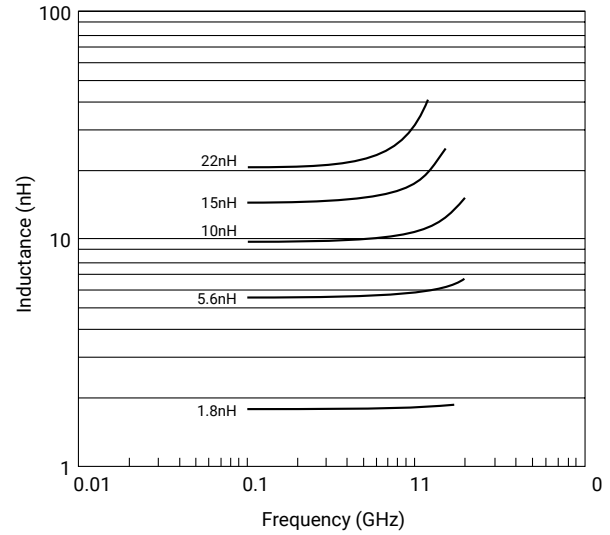

Measured on HP4291A and
Wiltron 360 Vector Analyzer

Maximum Temperature Rise
at 25°C ambient temperature (on FR-4)
L0805

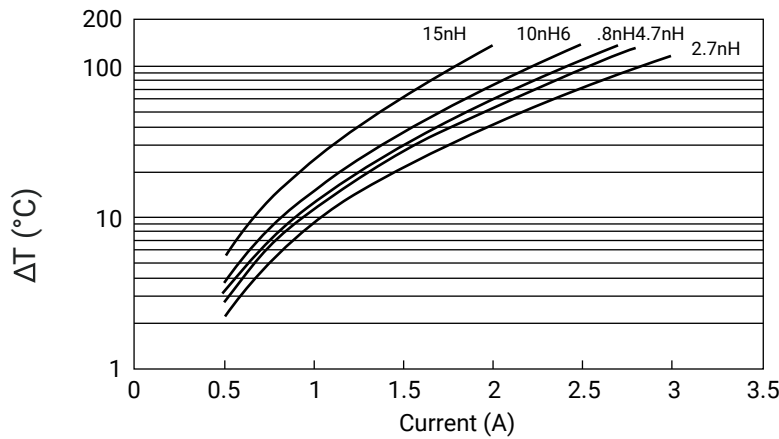

Temperature rise will typically be no higher than shown by the graph

Accu-L® Series

AEC-Q200 High-Q RF Inductor - L0402 & L0805

FINAL QUALITY INSPECTION

Finished parts are tested for electrical parameters and visual/mechanical characteristics.

Parts are 100% tested for inductance at 450MHz. Parts are 100% tested for RDC. Each production lot is evaluated on a sample basis for:

- Q at test frequency
- Static Humidity Resistance: 85°C, 85% RH, 160 hours
- Endurance: 125°C, IR, 4 hours

ENVIRONMENTAL CHARACTERISTICS

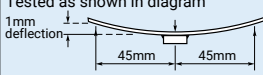
Test	Conditions	Requirement
Solderability	Components completely immersed in a solder bath at 235 ± 5°C for 2 secs.	Terminations to be well tinned. No visible damage.
Leach Resistance	Components completely immersed in a solder bath at 260 ± 5°C for 60 secs.	Dissolution of termination faces ≤ 15% of area. Dissolution of termination edges ≤ 25% of length.
Storage	12 months minimum with components stored in "as received" packaging.	Good solderability
Shear	Components mounted to a substrate. A force of 5N applied normal to the line joining the terminations and in a line parallel to the substrate.	No visible damage
Rapid Change of Temperature	Components mounted to a substrate. 5 cycles -55°C to +125°C.	No visible damage
Bend Strength	Tested as shown in diagram 	No visible damage
Temperature Coefficient of Inductance (TCL)	Component placed in environmental chamber -55°C to +125°C.	+0 to +125 ppm/°C (typical) $TCL = \frac{L_2 - L_1}{L_1 (T_2 - T_1)} \cdot 10^6$ $T_1 = 25^\circ\text{C}$

HANDLING

SMD chips should be handled with care to avoid damage or contamination from perspiration and skin oils. The use of plastic tipped tweezers or vacuum pick-ups is strongly recommended for individual components. Bulk handling should ensure that abrasion and mechanical shock are minimized. For automatic equipment, taped and reeled product is the ideal medium for direct presentation to the placement machine.

CIRCUIT BOARD TYPE

All flexible types of circuit boards may be used (e.g. FR-4, G-10) and also alumina.

For other circuit board materials, please consult factory

COMPONENT PAD DESIGN

Component pads must be designed to achieve good joints and minimize component movement during soldering. Pad designs are given below for both wave and reflow soldering.

The basis of these designs is:

- Pad width equal to component width. It is permissible to decrease this to as low as 85% of component width but it is not advisable to go below this.
- Pad overlap about 0.3mm.
- Pad extension about 0.3mm for reflow.
Pad extension about 0.8mm for wave soldering.

REFLOW SOLDERING DIMENSIONS: millimeter (inches)

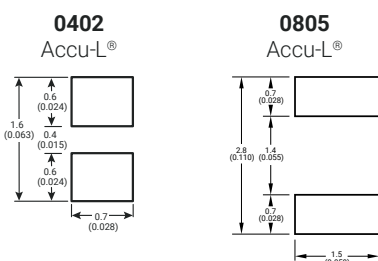

PREHEAT & SOLDERING

The rate of preheat in production should not exceed 4°C/second. It is recommended not to exceed 2°C/second.

Temperature differential from preheat to soldering should not exceed 150°C.

For further specific application or process advice, please consult KYOCERA AVX.

HAND SOLDERING & REWORK

Hand soldering is permissible. Preheat of the PCB to 100°C is required. The most preferable technique is to use hot air soldering tools. Where a soldering iron is used, a temperature controlled model not exceeding 30 watts should be used and set to not more than 260°C. Maximum allowed time at temperature is 1 minute. When hand soldering, the base side (white side) must be soldered to the board.

COOLING

After soldering, the assembly should preferably be allowed to cool naturally. In the event of assisted cooling, similar conditions to those recommended for preheating should be used.

CLEANING RECOMMENDATIONS

Care should be taken to ensure that the devices are thoroughly cleaned of flux residues, especially the space beneath the device. Such residues may otherwise become conductive and effectively offer a lossy bypass to the device. Various recommended cleaning conditions (which must be optimized for the flux system being used) are as follows:

Cleaning liquids..... i-propanol, ethanol, acetylacetone, water, and other standard PCB cleaning liquids.

Ultrasonic conditions... power – 20w/liter max.
frequency – 20kHz to 45kHz.

Temperature..... 80°C maximum (if not otherwise limited by chosen solvent system).

Time..... 5 minutes max

STORAGE CONDITIONS

Recommended storage conditions for Accu-L® prior to use are as follows:

Temperature..... 15°C to 35°C

Humidity ≤65%

Air Pressure..... 860mbar to 1060mbar

RECOMMENDED SOLDERING PROFILE

