

CAPPED 18-24 AWG: 9176-700



General Information



The market and applications for simple and reliable discrete Wire-to-Board connectors continue to evolve. KYOCERA AVX first introduced the 9176 series of surface mountable Insulation Displacement Connectors (IDC) in 2007. Developed for harsh industrial and automotive applications, these connectors have been used in hundreds of applications from today's "Smart Meter" all the way down to a simple sensor termination to a PCB. Size and performance has been one of the key factors for selecting this connector in terminating 18-24AWG wires to a PCB.

The next generation of IDC connector moves beyond all of the technical and performance attributes to address the "User Friendliness" of the product. By changing the insulator from acting as a connector body and make it more like a contact carrier, the insulator becomes the wire location and insertion aid without any special tools. The wire is just inserted into the cap (no stripping required) and then pressed down to provide a secure "Gas Tight" termination. This configuration simplifies and cost reduces the entire wire termination process for connecting discrete wires to a PCB.

APPLICATIONS

- Connecting discrete wire components to a PCB
- Bringing power and signals onto a PCB
- Daisy chaining PCB's together to create a continuous string
- Reference Product Specification 201-01-140

FEATURES AND BENEFITS

- IDC contact provides a gas-tight connection to the PCB for long term reliability
- Plastic cap retains the contacts in position prior to automatic placement, then acts as the assembly tool to terminate the wires; no special tooling.
- Tested to automotive levels on shock, vibration and temperature cycling for reliability
- Identical contact and footprint pattern to the existing 9176 for full backward compatibility and functionality
- The IDC contact reduces the total applied cost versus solder or crimp processes
- Connectors are available in two configurations for maximum flexibility; End and Through Wire

ELECTRICAL

- Current Rating: 10 Amps / Contact
- Voltage Rating: 300 VAC

ENVIRONMENTAL

- Operating Temperature: -40°C to +125°C

MECHANICAL

- Insulator Material: Nylon UL94VO
- Contact Material: Phosphor Bronze
- Plating: Tin over Nickel

HOW TO ORDER

00 Prefix
9176 Series
00X Number of Ways
 001 = 1
 002 = 2
 003 = 3

7XX Wire Gauge Size
Capped - IDC Connector

Code	Accepted Wire Gauge	Wire Insulation
701	18 AWG Stranded	Ø 1.6 - 2.1
711	20 AWG Solid and Stranded	Ø 1.6 - 2.1
722	22 AWG Solid and Stranded	Ø 1.1 - 1.6
732	24 AWG Solid and Stranded	Ø 1.1 - 1.6

X Insulator Color
All Sizes
9 = UL White (Standard)
8 = UL Black (Special Order)
 One Way Only (Special Order)
 2 = UL Brown
 3 = UL Blue
 4 = UL Yellow
 5 = UL Red
 6 = UL Green
 7 = UL Orange

X Cap Options

Code	Cap Option	Description	Detail
0	Through Wire	Allows wire to be terminated at any point	Pages 26 - 28
9	Wire Stop	Terminates end of wire End Protected by stop face	Pages 29 - 31

6 Plating Option
 6 = Pure Tin all over



Certification: UL File #E90723

CAPPED 18-24 AWG: 9176-700

1 Position - Through Wire

18 - 24 AWG 1 WAY IDC CONNECTOR THROUGH WIRE CAPPED IDC

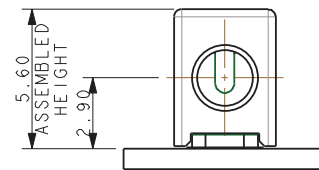
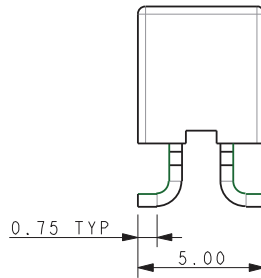
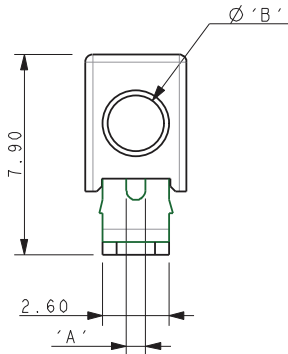
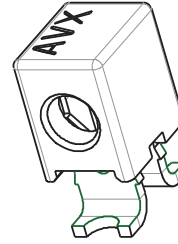
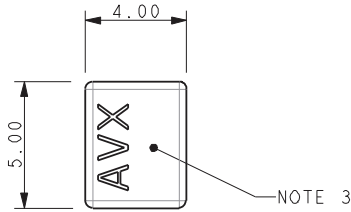

MOUNTED ON PCB

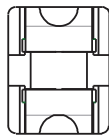

NOTES:

1. 1 WAY CONNECTOR FOR IDC WIRE TO BOARD CONNECTION. PRE-ASSEMBLED THROUGH WIRE CAP, CODE REFER TO PAGE 27.
2. CONTACT/CAP TO MATCH 20AWG-24AWG SOLID AND STRANDED WIRES, 18AWG WILL ONLY ACCEPT STRANDED WIRES, SEE TABLE.
3. FLAT FACE ON TOP OF CAP TO AID PICK AND PLACE ASSEMBLY.
4. FOR FULL PRODUCT SPECIFICATION ON STANDARD CONNECTORS REFER TO ELCO SPEC 201-01-138, UL COMPONENTS REFER TO ELCO SPEC 201-01-138UL.
5. ASSEMBLY PROCEDURE, REFER TO APPLICATION NOTES 201-01-140.
6. GENERAL TOLERANCE ± 0.20 UNLESS STATED.
7. PACKED IN TAPE AND REEL, QUANTITY PER REEL 600.
8. CONNECTOR OUTLINE.
9. CONTACT MATERIAL: TIN PLATED COPPER ALLOY.
10. INSULATION MATERIAL: HIGH TEMPERATURE NYLON, GLASS FILLED. UL94 V-0, COLOR REFER TO PAGE 27.
11. GENERAL TOLERANCE ± 0.20 UNLESS STATED.
12. FOR UL PRODUCT CODES UL REFERENCE E90723 (US AND CANADA).

Code	Accepted Wire Gauge	A	Wire Insulation	B
701	18 AWG Stranded	0.74	$\varnothing 1.621$	2.1
711	20 AWG Solid and Stranded	0.60	$\varnothing 1.621$	2.1
722	22 AWG Solid and Stranded	0.47	$\varnothing 1.1-1.6$	1.6
732	24 AWG Solid and Stranded	0.37	$\varnothing 1.1-1.6$	1.6

PACKING DETAILS

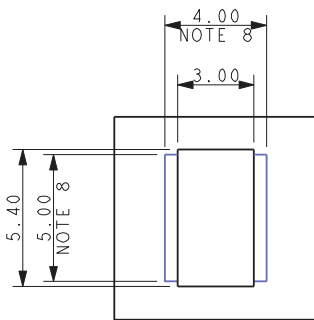

SUGGEST PCB LAYOUT

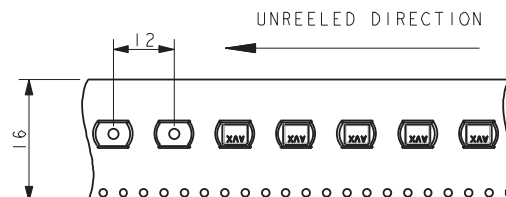
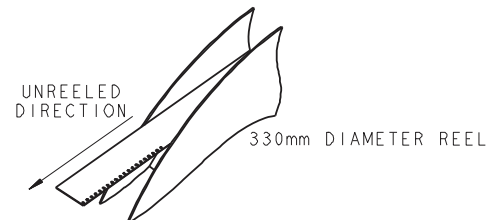

QUANTITY PER REEL 600

CAPPED 18-24 AWG: 9176-700

2 Position - Through Wire

18 - 24 AWG 2 WAY IDC CONNECTOR THROUGH WIRE CAPPED IDC

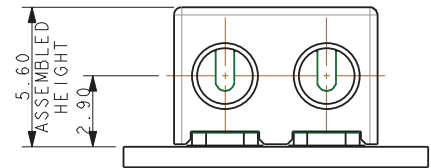
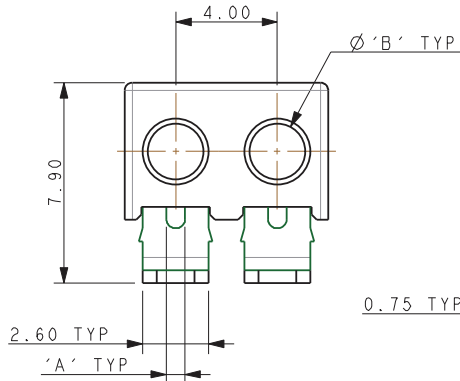
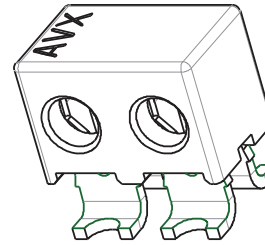
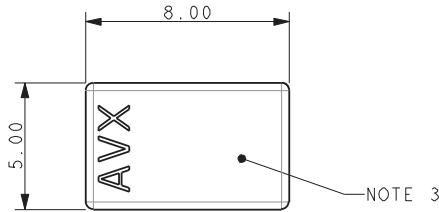

MOUNTED ON PCB

ALL TAILS WITHIN 0.10 COPLANARITY TOLERANCE

NOTES:

- 2 WAY CONNECTOR FOR IDC WIRE TO BOARD CONNECTION. PRE-ASSEMBLED THROUGH WIRE CAP, CODE REFER TO PAGE 27.
- CONTACT/CAP TO MATCH 20AWG-24AWG SOLID AND STRANDED WIRES, 18AWG WILL ONLY ACCEPT STRANDED WIRES, SEE TABLE.
- FLAT FACE ON TOP OF CAP TO AID PICK AND PLACE ASSEMBLY.
- FOR FULL PRODUCT SPECIFICATION ON STANDARD CONNECTORS REFER TO ELCO SPEC 201-01-138, UL COMPONENTS REFER TO ELCO SPEC 201-01-138UL.
- ASSEMBLY PROCEDURE, REFER TO APPLICATION NOTES 201-01-140.
- GENERAL TOLERANCE ± 0.20 UNLESS STATED.
- PACKED IN TAPE AND REEL, QUANTITY PER REEL 600.
- CONNECTOR OUTLINE.
- CONTACT MATERIAL: TIN PLATED COPPER ALLOY.
- INSULATION MATERIAL: HIGH TEMPERATURE NYLON, GLASS FILLED. UL94 V-0, COLOR REFER TO PAGE 27.
- GENERAL TOLERANCE ± 0.20 UNLESS STATED.
- FOR UL PRODUCT CODES UL REFERENCE E90723 (US AND CANADA).

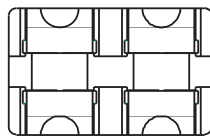

Code	Accepted Wire Gauge	A	Wire Insulation	B
701	18 AWG Stranded	0.74	$\emptyset 1.621$	2.1
711	20 AWG Solid and Stranded	0.60	$\emptyset 1.621$	2.1
722	22 AWG Solid and Stranded	0.47	$\emptyset 1.1-1.6$	1.6
732	24 AWG Solid and Stranded	0.37	$\emptyset 1.1-1.6$	1.6

PACKING DETAILS

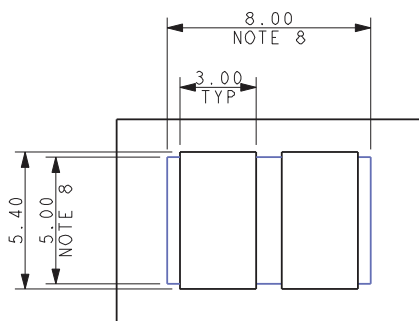

SUGGEST PCB LAYOUT

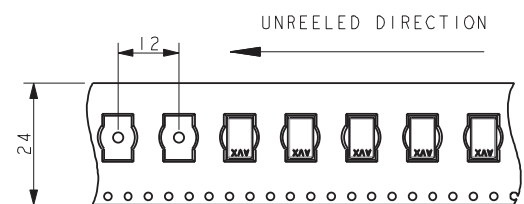
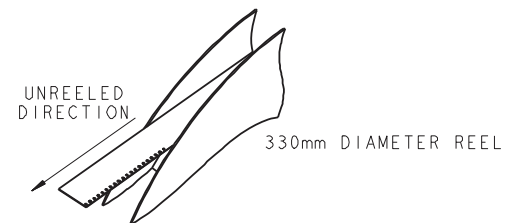

QUANTITY PER REEL 600

CAPPED 18-24 AWG: 9176-700

3 Position - Through Wire

18 - 24 AWG 3 WAY IDC CONNECTOR THROUGH WIRE CAPPED IDC

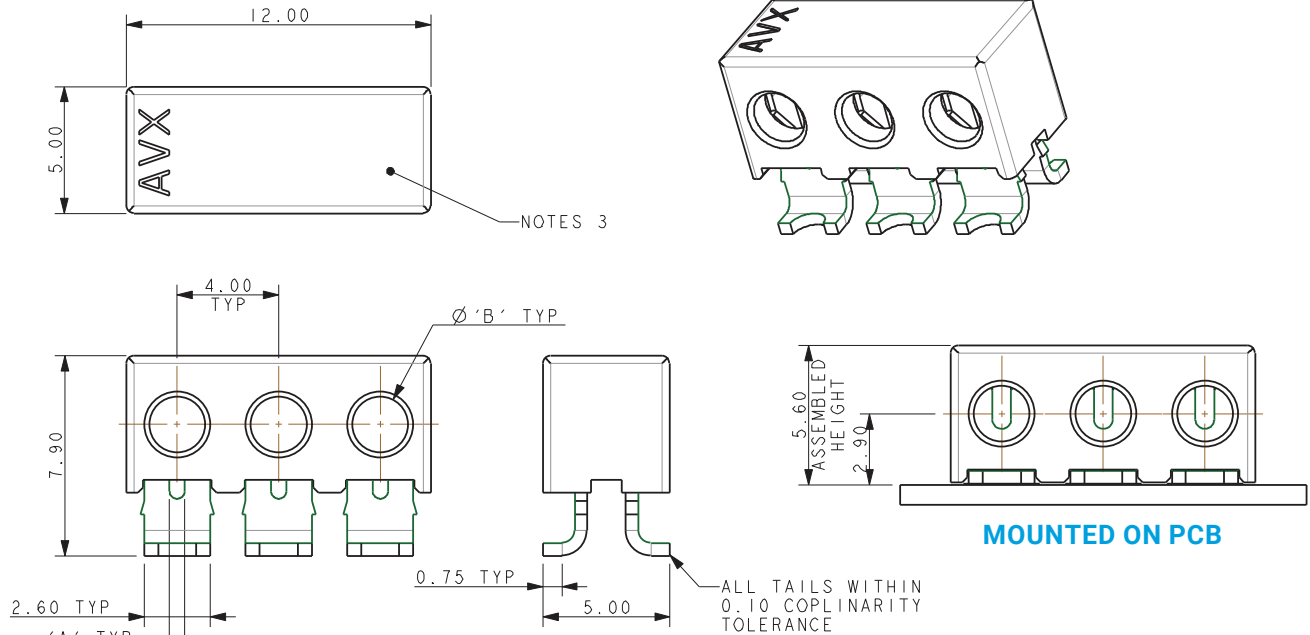

NOTES:

1. 3 WAY CONNECTOR FOR IDC WIRE TO BOARD CONNECTION. PRE-ASSEMBLED THROUGH WIRE CAP, CODE REFER TO PAGE 27.
2. CONTACT/CAP TO MATCH 20AWG-24AWG SOLID AND STRANDED WIRES, 18AWG WILL ONLY ACCEPT STRANDED WIRES, SEE TABLE.
3. FLAT FACE ON TOP OF CAP TO AID PICK AND PLACE ASSEMBLY.
4. FOR FULL PRODUCT SPECIFICATION ON STANDARD CONNECTORS REFER TO ELCO SPEC 201-01-138, UL COMPONENTS REFER TO ELCO SPEC 201-01-138UL.
5. ASSEMBLY PROCEDURE, REFER TO APPLICATION NOTES 201-01-140.
6. GENERAL TOLERANCE ± 0.20 UNLESS STATED.
7. PACKED IN TAPE AND REEL, QUANTITY PER REEL 600.
8. CONNECTOR OUTLINE.
9. CONTACT MATERIAL: TIN PLATED COPPER ALLOY.
10. INSULATION MATERIAL: HIGH TEMPERATURE NYLON, GLASS FILLED. UL94 V-0, COLOR REFER TO PAGE 27.
11. GENERAL TOLERANCE ± 0.20 UNLESS STATED.
12. FOR UL PRODUCT CODES UL REFERENCE E90723 (US AND CANADA).

Code	Accepted Wire Gauge	A	Wire Insulation	B
701	18 AWG Stranded	0.74	Ø1.6-2.1	2.1
711	20 AWG Solid and Stranded	0.60	Ø1.6-2.1	2.1
722	22 AWG Solid and Stranded	0.47	Ø 1.1-1.6	1.6
732	24 AWG Solid and Stranded	0.37	Ø 1.1-1.6	1.6

PACKING DETAILS

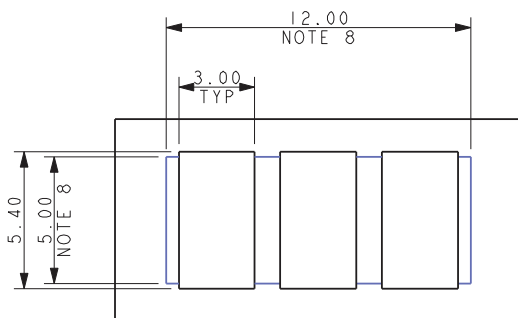

SUGGEST PCB LAYOUT

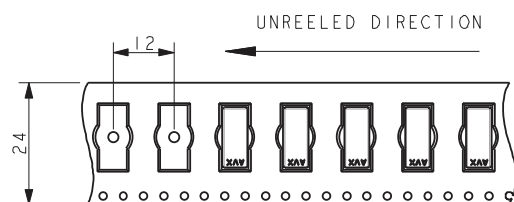
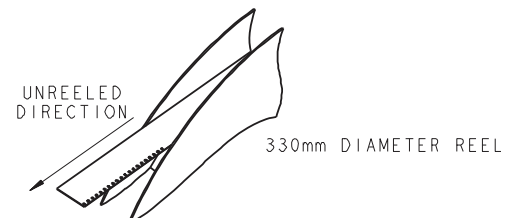

QUANTITY PER REEL 600

CAPPED 18-24 AWG: 9176-700

1 Position - Wire Stop

18 - 24 AWG 1 WAY IDC CONNECTOR WIRE STOP CAPPED IDC

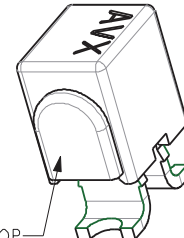
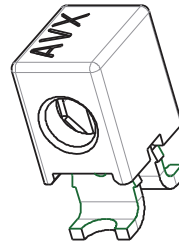
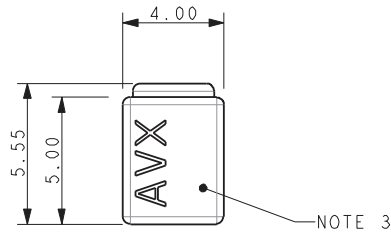

WIRE STOP
NOTE 11

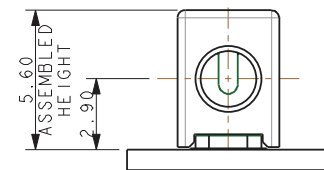
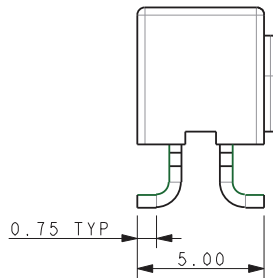
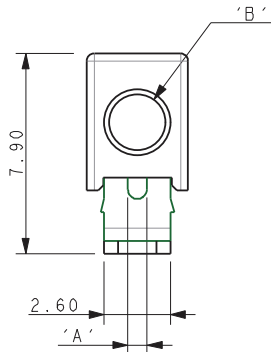

MOUNTED ON PCB

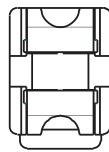

NOTES:

1. 1 WAY CONNECTOR FOR IDC WIRE TO BOARD CONNECTION. PRE-ASSEMBLED WIRE STOP CAP, CODE REFER TO PAGE 27.
2. CONTACT/CAP TO MATCH 20AWG-24AWG SOLID AND STRANDED WIRES, 18AWG WILL ONLY ACCEPT STRANDED WIRES, SEE TABLE.
3. FLAT FACE ON TOP OF CAP TO AID PICK AND PLACE ASSEMBLY.
4. FOR FULL PRODUCT SPECIFICATION ON STANDARD CONNECTORS REFER TO ELCO SPEC 201-01-138, UL COMPONENTS REFER TO ELCO SPEC 201-01-138UL.
5. ASSEMBLY PROCEDURE, REFER TO APPLICATION NOTES 201-01-140.
6. GENERAL TOLERANCE ± 0.20 UNLESS STATED.
7. PACKED IN TAPE AND REEL, QUANTITY PER REEL 600.
8. CONNECTOR OUTLINE.
9. CONTACT MATERIAL: TIN PLATED COPPER ALLOY.
10. INSULATION MATERIAL: HIGH TEMPERATURE NYLON, GLASS FILLED. UL94 V-0, COLOR REFER TO PAGE 27.
11. GENERAL TOLERANCE ± 0.20 UNLESS STATED.
12. FOR UL PRODUCT CODES UL REFERENCE E90723 (US AND CANADA).

Code	Accepted Wire Gauge	A	Wire Insulation	B
701	18 AWG Stranded	0.74	$\varnothing 1.6-2.1$	2.1
711	20 AWG Solid and Stranded	0.60	$\varnothing 1.6-2.1$	2.1
722	22 AWG Solid and Stranded	0.47	$\varnothing 1.1-1.6$	1.6
732	24 AWG Solid and Stranded	0.37	$\varnothing 1.1-1.6$	1.6

PACKING DETAILS

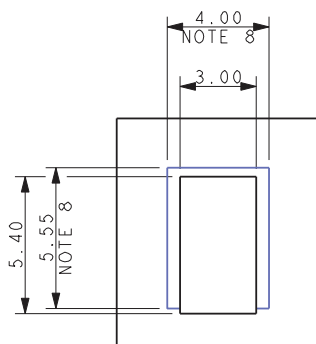

SUGGEST PCB LAYOUT

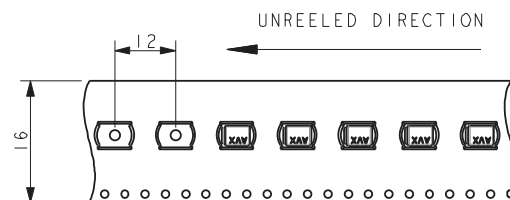
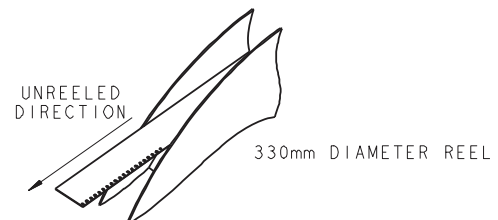

QUANTITY PER REEL 600

CAPPED 18-24 AWG: 9176-700

2 Position - Wire Stop

18 - 24 AWG 2 WAY IDC CONNECTOR WIRE STOP CAPPED IDC

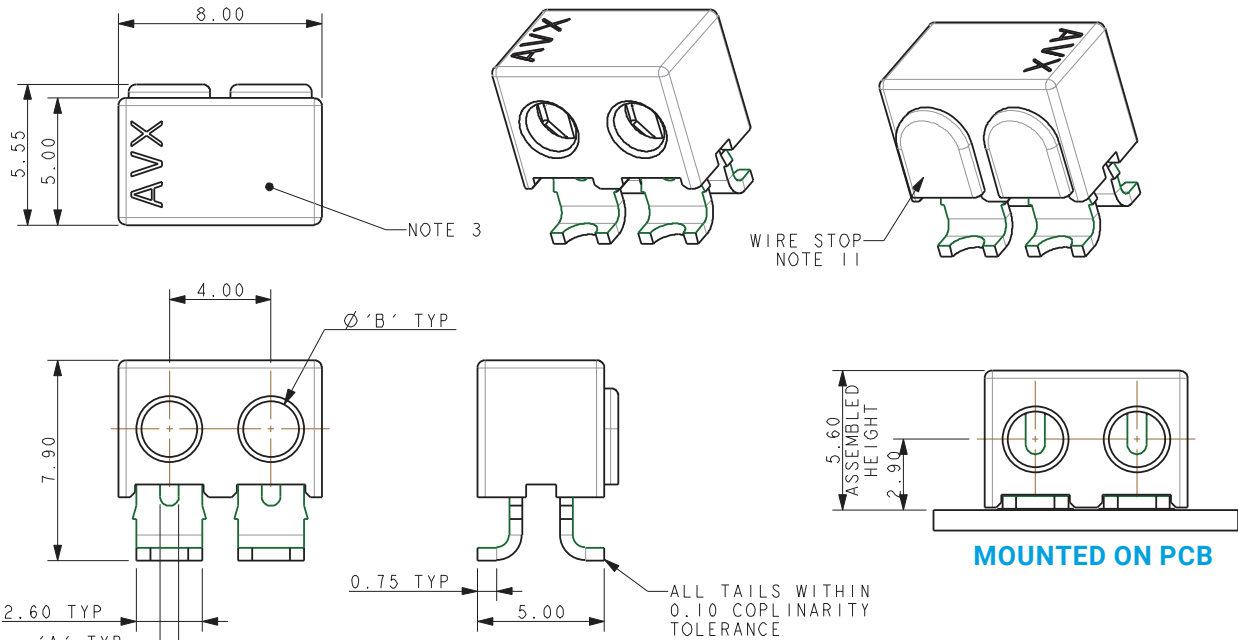

NOTES:

1. 2 WAY CONNECTOR FOR IDC WIRE TO BOARD CONNECTION. PRE-ASSEMBLED WIRE STOP CAP, CODE REFER TO PAGE 27.
2. CONTACT/CAP TO MATCH 20AWG-24AWG SOLID AND STRANDED WIRES, 18AWG WILL ONLY ACCEPT STRANDED WIRES, SEE TABLE.
3. FLAT FACE ON TOP OF CAP TO AID PICK AND PLACE ASSEMBLY.
4. FOR FULL PRODUCT SPECIFICATION ON STANDARD CONNECTORS REFER TO ELCO SPEC 201-01-138, UL COMPONENTS REFER TO ELCO SPEC 201-01-138UL.
5. ASSEMBLY PROCEDURE, REFER TO APPLICATION NOTES 201-01-140.
6. GENERAL TOLERANCE ± 0.20 UNLESS STATED.
7. PACKED IN TAPE AND REEL, QUANTITY PER REEL 600.
8. CONNECTOR OUTLINE.
9. CONTACT MATERIAL: TIN PLATED COPPER ALLOY.
10. INSULATION MATERIAL: HIGH TEMPERATURE NYLON, GLASS FILLED. UL94 V-0, COLOR REFER TO PAGE 27.
11. GENERAL TOLERANCE ± 0.20 UNLESS STATED.
12. FOR UL PRODUCT CODES UL REFERENCE E90723 (US AND CANADA).

Code	Accepted Wire Gauge	A	Wire Insulation	B
701	18 AWG Stranded	0.74	$\varnothing 1.6-2.1$	2.1
711	20 AWG Solid and Stranded	0.60	$\varnothing 1.6-2.1$	2.1
722	22 AWG Solid and Stranded	0.47	$\varnothing 1.1-1.6$	1.6
732	24 AWG Solid and Stranded	0.37	$\varnothing 1.1-1.6$	1.6

PACKING DETAILS

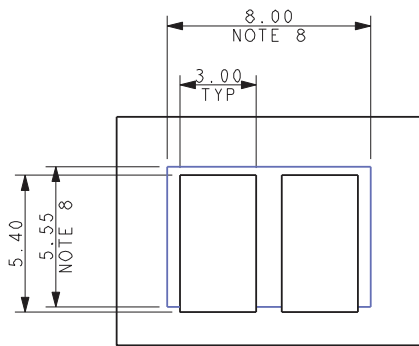

SUGGEST PCB LAYOUT

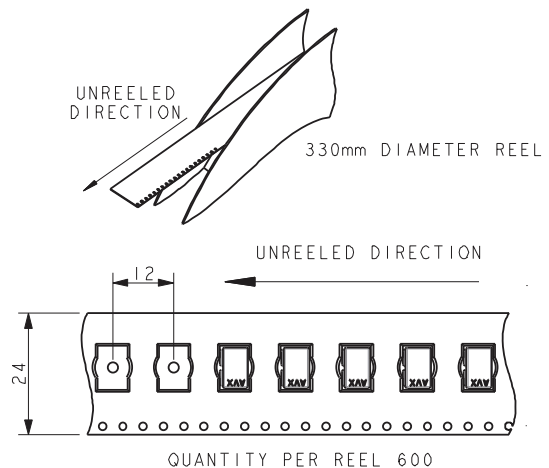

CAPPED 18-24 AWG: 9176-700

3 Position - Wire Stop

18 - 24 AWG 3 WAY IDC CONNECTOR WIRE STOP CAPPED IDC

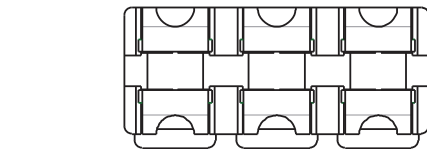
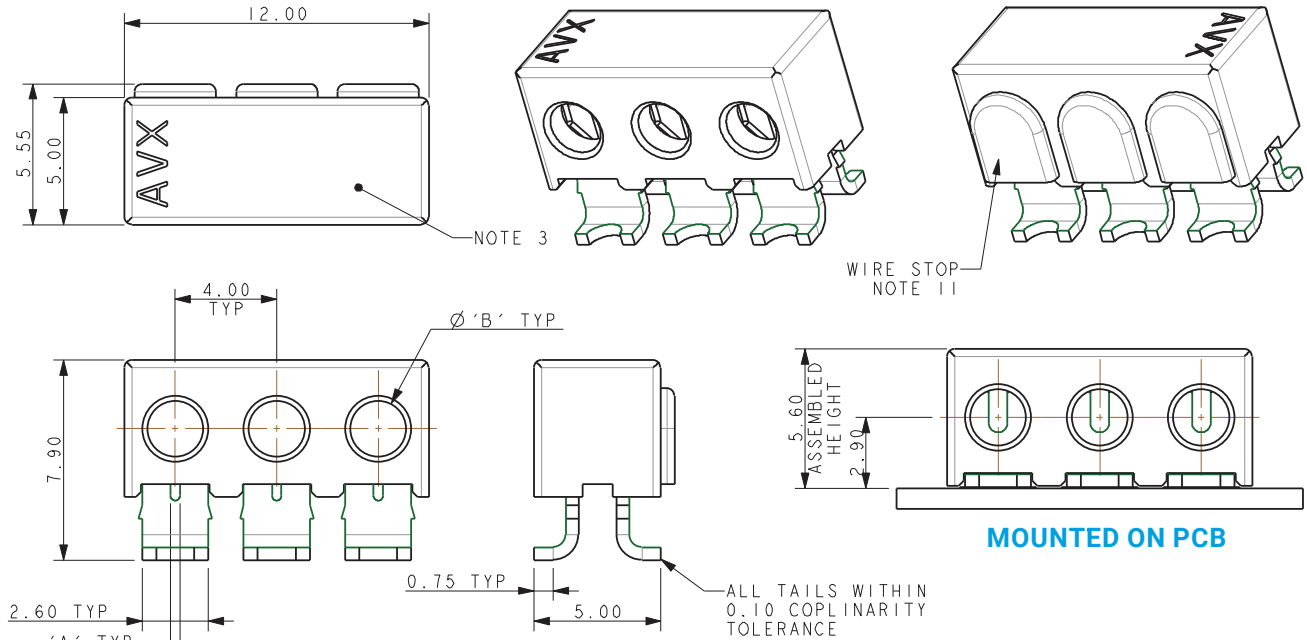

NOTES:

- 3 WAY CONNECTOR FOR IDC WIRE TO BOARD CONNECTION. PRE-ASSEMBLED WIRE STOP CAP, CODE REFER TO PAGE 27.
- CONTACT/CAP TO MATCH 20AWG-24AWG SOLID AND STRANDED WIRES, 18AWG WILL ONLY ACCEPT STRANDED WIRES, SEE TABLE.
- FLAT FACE ON TOP OF CAP TO AID PICK AND PLACE ASSEMBLY.
- FOR FULL PRODUCT SPECIFICATION ON STANDARD CONNECTORS REFER TO ELCO SPEC 201-01-138, UL COMPONENTS REFER TO ELCO SPEC 201-01-138UL.
- ASSEMBLY PROCEDURE, REFER TO APPLICATION NOTES 201-01-140.
- GENERAL TOLERANCE ± 0.20 UNLESS STATED.
- PACKED IN TAPE AND REEL, QUANTITY PER REEL 600.
- CONNECTOR OUTLINE.
- CONTACT MATERIAL: TIN PLATED COPPER ALLOY.
- INSULATION MATERIAL: HIGH TEMPERATURE NYLON, GLASS FILLED. UL94 V-0, COLOR REFER TO PAGE 27.
- GENERAL TOLERANCE ± 0.20 UNLESS STATED.
- FOR UL PRODUCT CODES UL REFERENCE E90723 (US AND CANADA).

Code	Accepted Wire Gauge	A	Wire Insulation	B
701	18 AWG Stranded	0.74	Ø1.6-2.1	2.1
711	20 AWG Solid and Stranded	0.60	Ø1.6-2.1	2.1
722	22 AWG Solid and Stranded	0.47	Ø 1.1-1.6	1.6
732	24 AWG Solid and Stranded	0.37	Ø 1.1-1.6	1.6

PACKING DETAILS

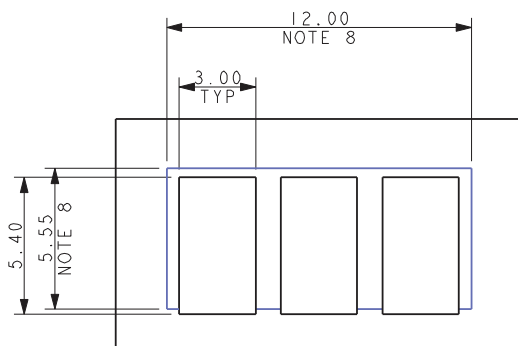

SUGGEST PCB LAYOUT

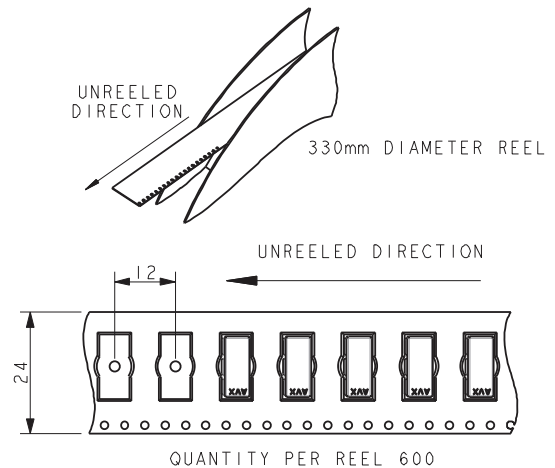

18-24 AWG ASSEMBLED CAPPED IDC CONNECTORS

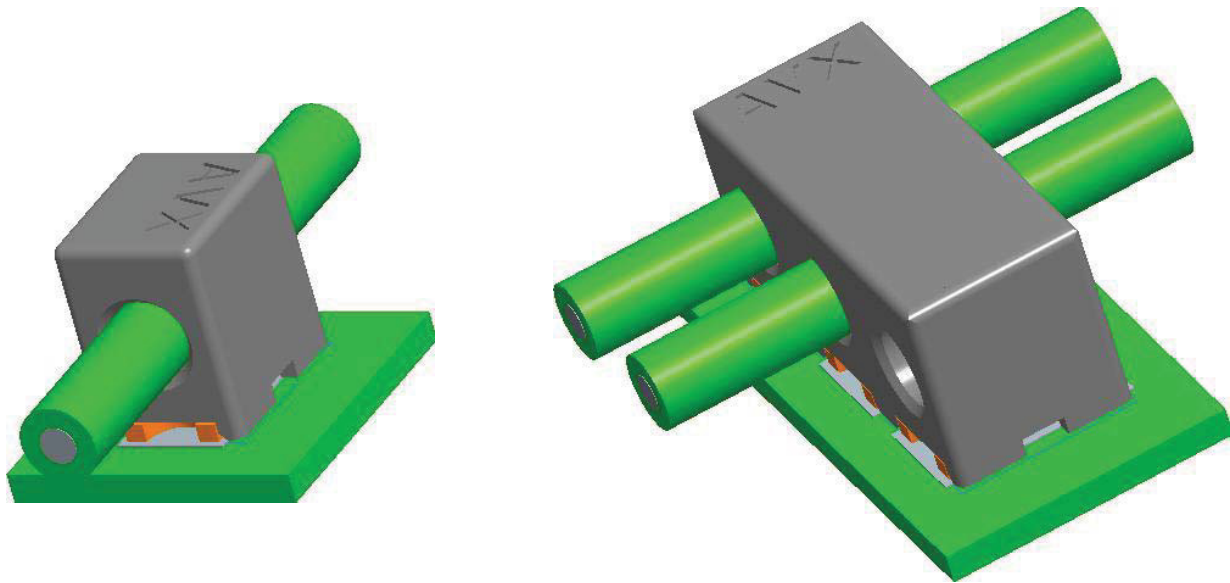

TYPICAL THROUGH WIRE ASSEMBLY

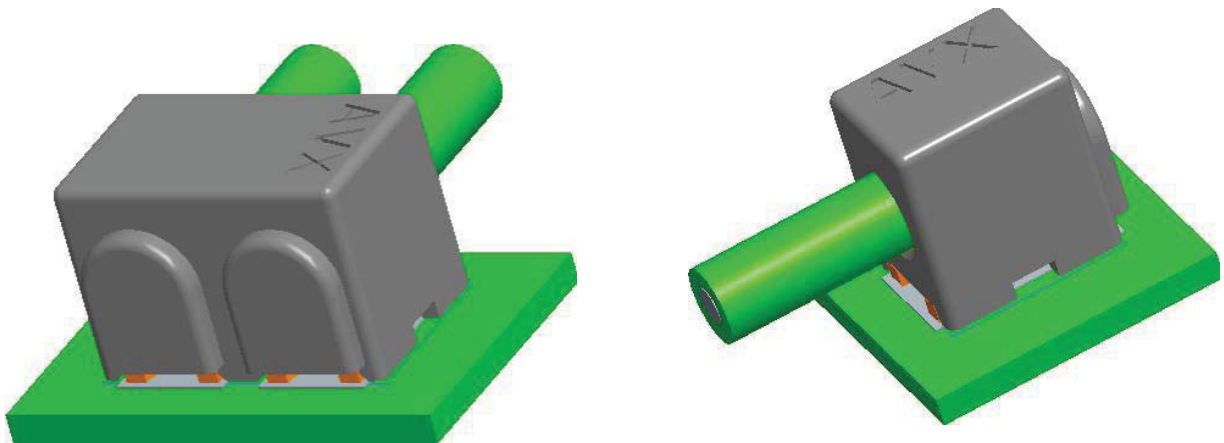

TYPICAL WIRE STOP ASSEMBLY