

# BATTERY CONNECTORS

## Right Angle 3.0mm Pitch 9155-300



A further addition to the battery connector range offered by KYOCERA AVX is a 90 degree version. On a 3mm pitch, offered in 2 to 6 contact positions and rated as with all of the battery range at 3 amps. The connector's design is small and compact to minimize its profile yet stable while having a contact point 4.61mm above the PCB.

The stability comes from the addition of extra SMT anchor brackets that are in between the SMT contact pads and both at the front of the connector and within the row of the contact SMT pads.

As with the other 9155 series of battery connectors offered by KYOCERA AVX the 90 degree version is rated at 3 amps and 5000 mating cycles, RoHS compliant and using high temperature plastic enables the connectors to be processed at up to 260°C.

### APPLICATIONS

- Mobile phones
- Digital music players
- Hand held terminals
- Data terminals or any other small portable device

### FEATURES AND BENEFITS

- Simple designed spring contact
- End to end stackable for larger pin counts
- Additional contact anchor brackets to added stability on the PCB
- Robust to shock and vibration
- Selectively plated contact area

### ELECTRICAL

- Current Rating: 3 Amp / Contact
- Voltage Rating: 125 VAC

### ENVIRONMENTAL

- Operating Temperature: -40°C to +125°C

### MECHANICAL

- Insulator Material: Glass-Filled Nylon 46; UL94 HB
- Contact Material: Beryllium Copper
- Plating: Gold over Nickel
- Durability: 5000 Cycles

### HOW TO ORDER

<b>00</b>	<b>9155</b>	<b>00X</b>
Prefix	Series	No. of Ways
		2 = 002
		3 = 003
		4 = 004
		5 = 005
		6 = 006

<b>301</b>				
Right Angle Battery Connector				
<table border="1"> <thead> <tr> <th>Code</th> <th>Description</th> </tr> </thead> <tbody> <tr> <td>301</td> <td>Right Angle 3.00mm Battery Connector</td> </tr> </tbody> </table>	Code	Description	301	Right Angle 3.00mm Battery Connector
Code	Description			
301	Right Angle 3.00mm Battery Connector			

<b>00X</b>						
Plating Option						
<table border="1"> <thead> <tr> <th>Code</th> <th>Description</th> </tr> </thead> <tbody> <tr> <td>006</td> <td>0.4µm Selective Gold, Standard</td> </tr> <tr> <td>008</td> <td>0.8µm Selective Gold, Special Order</td> </tr> </tbody> </table>	Code	Description	006	0.4µm Selective Gold, Standard	008	0.8µm Selective Gold, Special Order
Code	Description					
006	0.4µm Selective Gold, Standard					
008	0.8µm Selective Gold, Special Order					



# BATTERY CONNECTORS

## Right Angle 3.0mm Pitch 9155-300

### 2 WAY RIGHT ANGLE BATTERY CONNECTOR

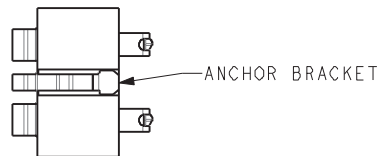
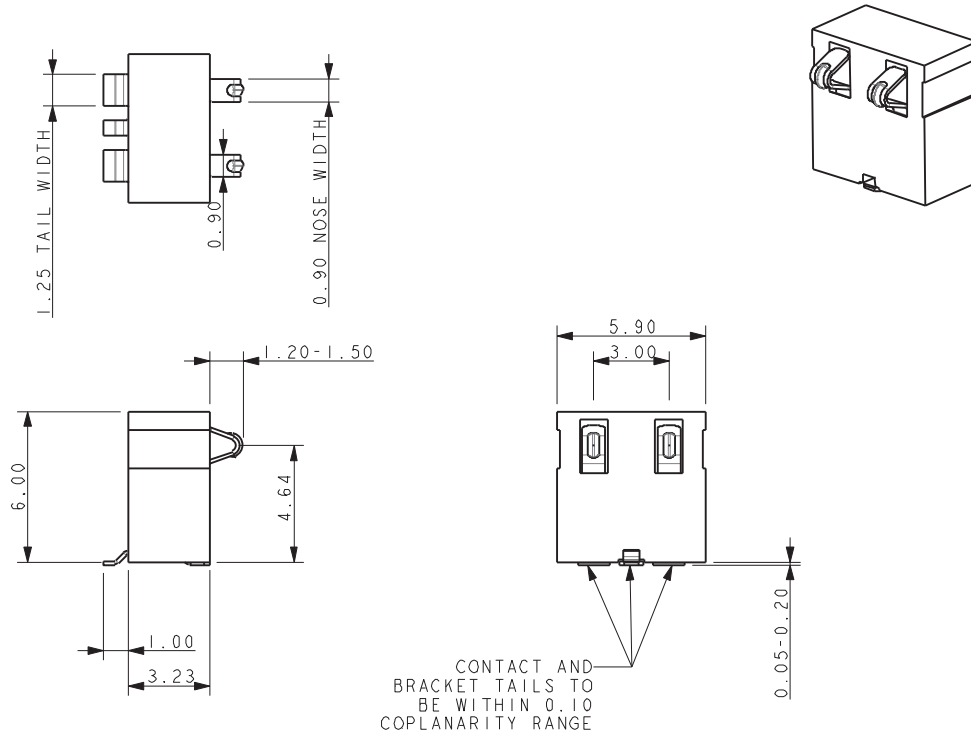

### PCB LAYOUT

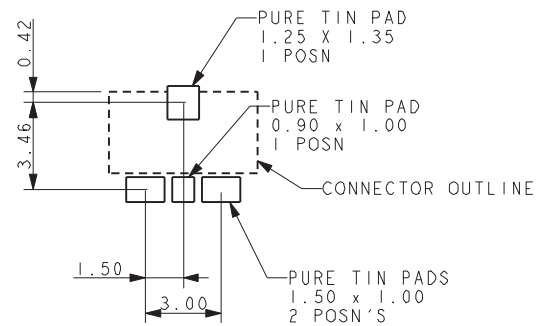

### PACKING DETAILS

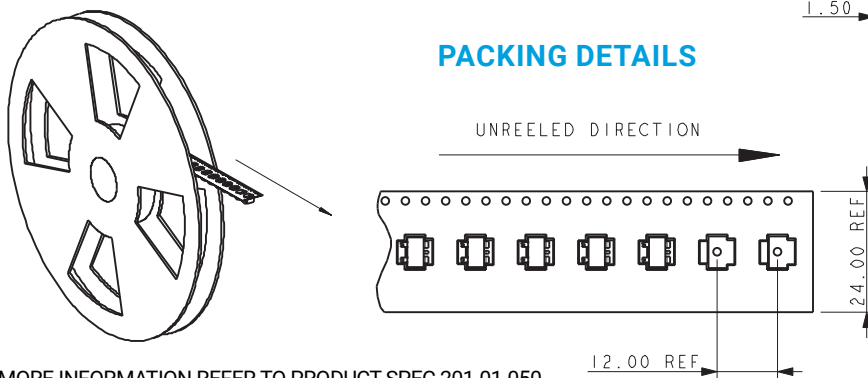

REEL QTY	800
LEADER	480MM
TRAILER	480MM

#### NOTES:

1. FOR MORE INFORMATION REFER TO PRODUCT SPEC 201-01-050.
2. GENERAL TOLERANCE  $\pm 0.20$  UNLESS OTHERWISE STATED.
3. FOR MATING PAD DETAILS REFER TO PAGE 29.
4. INSULATOR MATERIAL: 30% GLASS FILLED NYLON 46, UL94 V-O. COLOR BLACK.
5. CONTACT MATERIAL: BERYLLIUM COPPER.
6. CONTACT PLATING: SELECTIVE GOLD OVER NICKEL. PURE TIN ON TAILS.
7. BRACKET MATERIAL: PHOSPHOR BRONZE.
8. BRACKET PLATING: PURE TIN OVER NICKEL.

# BATTERY CONNECTORS

## Right Angle 3.0mm Pitch 9155-300

### 3 WAY RIGHT ANGLE BATTERY CONNECTOR

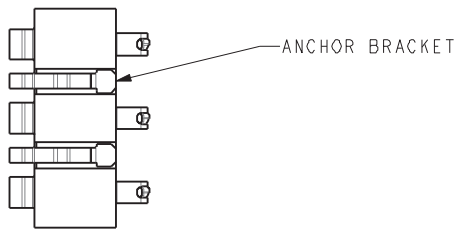
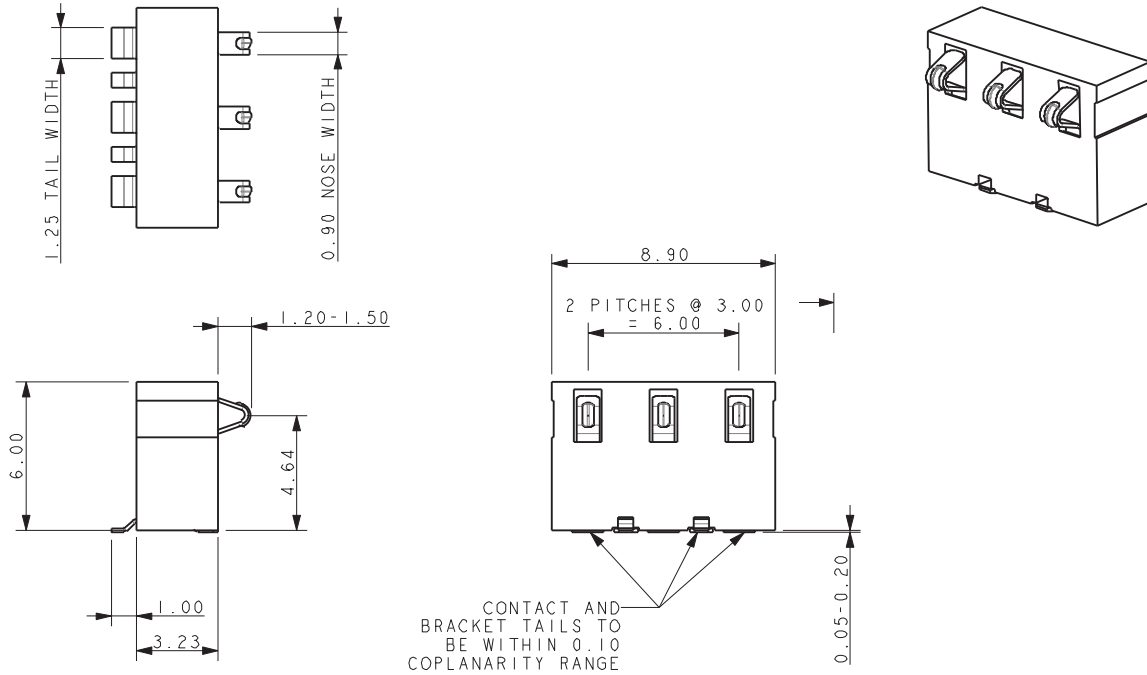

### PCB LAYOUT

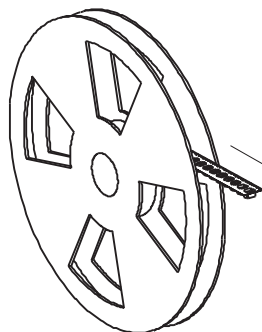
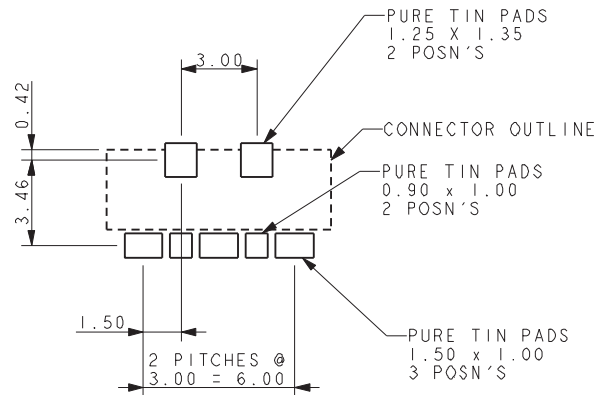

### PACKING DETAILS

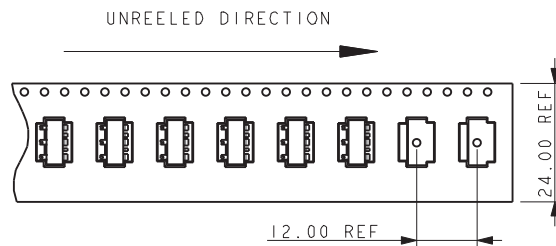

REEL QTY	800
LEADER	480MM
TRAILER	480MM

#### NOTES:

- FOR MORE INFORMATION REFER TO PRODUCT SPEC 201-01-050.
- GENERAL TOLERANCE  $\pm 0.20$  UNLESS OTHERWISE STATED.
- FOR MATING PAD DETAILS REFER TO PAGE 29.
- INSULATOR MATERIAL: 30% GLASS FILLED NYLON 46, UL94 V-O. COLOR BLACK.
- CONTACT MATERIAL: BERYLLIUM COPPER.
- CONTACT PLATING: SELECTIVE GOLD OVER NICKEL. PURE TIN ON TAILS.
- BRACKET MATERIAL: PHOSPHOR BRONZE.
- BRACKET PLATING: PURE TIN OVER NICKEL.

# BATTERY CONNECTORS

## Right Angle 3.0mm Pitch 9155-300

### 4 WAY RIGHT ANGLE BATTERY CONNECTOR

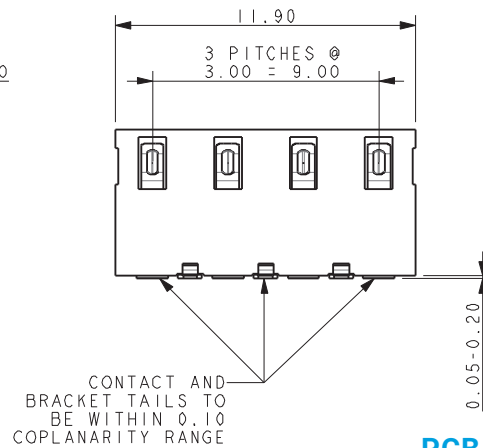
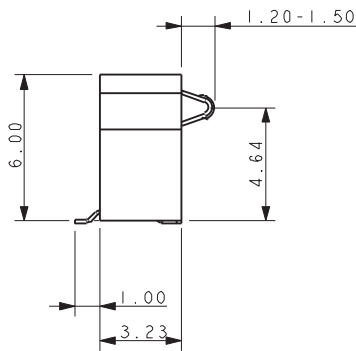
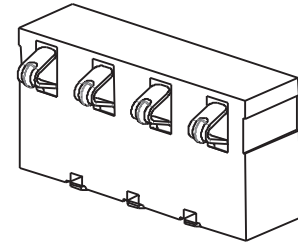
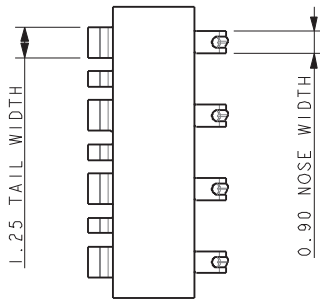

### PCB LAYOUT

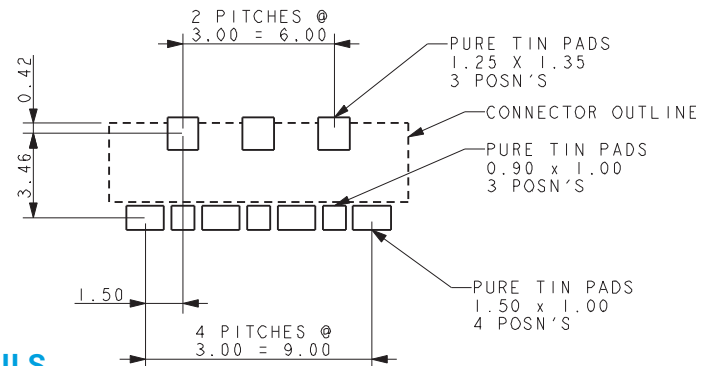
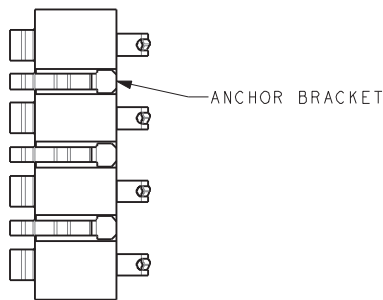

### PACKING DETAILS

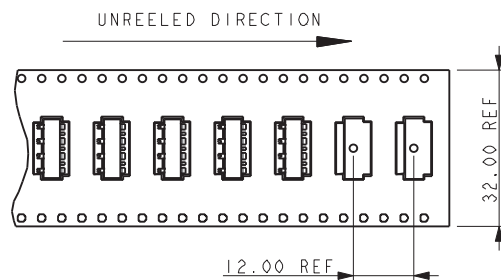
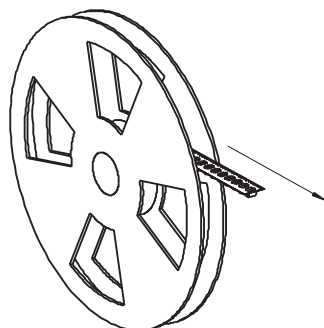

REEL QTY	800
LEADER	480MM
TRAILER	480MM

#### NOTES:

1. FOR MORE INFORMATION REFER TO PRODUCT SPEC 201-01-050.
2. GENERAL TOLERANCE  $\pm 0.20$  UNLESS OTHERWISE STATED.
3. FOR MATING PAD DETAILS REFER TO PAGE 29.
4. INSULATOR MATERIAL: 30% GLASS FILLED NYLON 46, UL94 V-O. COLOR BLACK.
5. CONTACT MATERIAL: BERYLLIUM COPPER.
6. CONTACT PLATING: SELECTIVE GOLD OVER NICKEL. PURE TIN ON TAILS.
7. BRACKET MATERIAL: PHOSPHOR BRONZE.
8. BRACKET PLATING: PURE TIN OVER NICKEL.

# BATTERY CONNECTORS

## Right Angle 3.0mm Pitch 9155-300

### 5 WAY RIGHT ANGLE BATTERY CONNECTOR

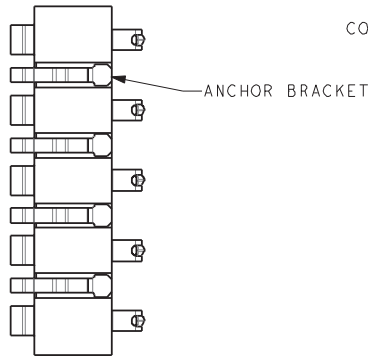
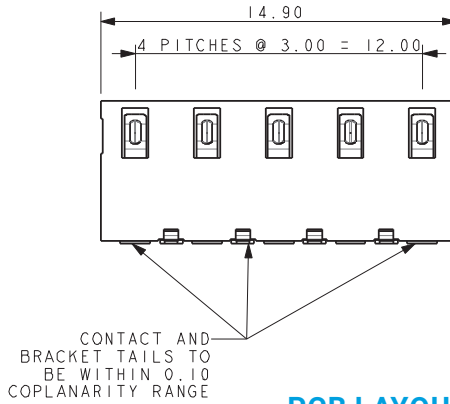
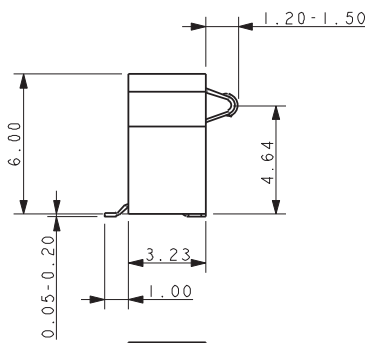
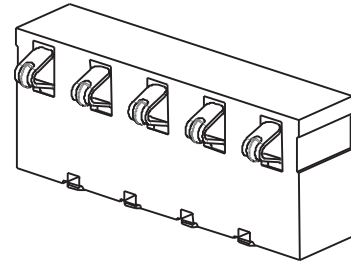
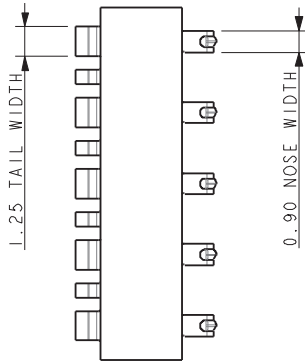

### PCB LAYOUT

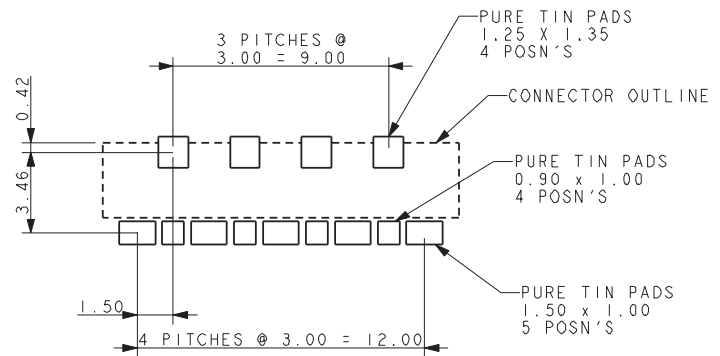

### PACKING DETAILS

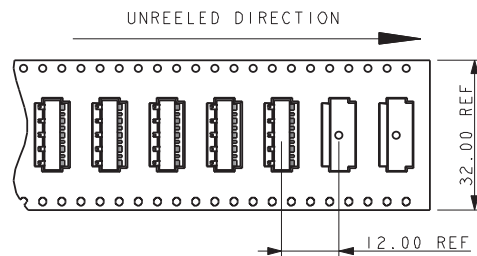
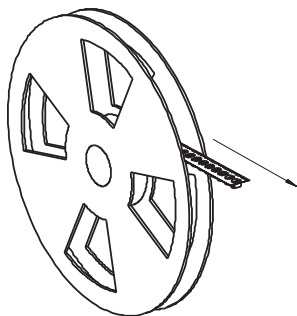

REEL QTY	800
LEADER	480MM
TRAILER	480MM

#### NOTES:

1. FOR MORE INFORMATION REFER TO PRODUCT SPEC 201-01-050.
2. GENERAL TOLERANCE  $\pm 0.20$  UNLESS OTHERWISE STATED.
3. FOR MATING PAD DETAILS REFER TO PAGE 29.
4. INSULATOR MATERIAL: 30% GLASS FILLED NYLON 46, UL94 V-O. COLOR BLACK.
5. CONTACT MATERIAL: BERYLLIUM COPPER.
6. CONTACT PLATING: SELECTIVE GOLD OVER NICKEL. PURE TIN ON TAILS.
7. BRACKET MATERIAL: PHOSPHOR BRONZE.
8. BRACKET PLATING: PURE TIN OVER NICKEL.

# BATTERY CONNECTORS

## Right Angle 3.0mm Pitch 9155-300

### 6 WAY RIGHT ANGLE BATTERY CONNECTOR

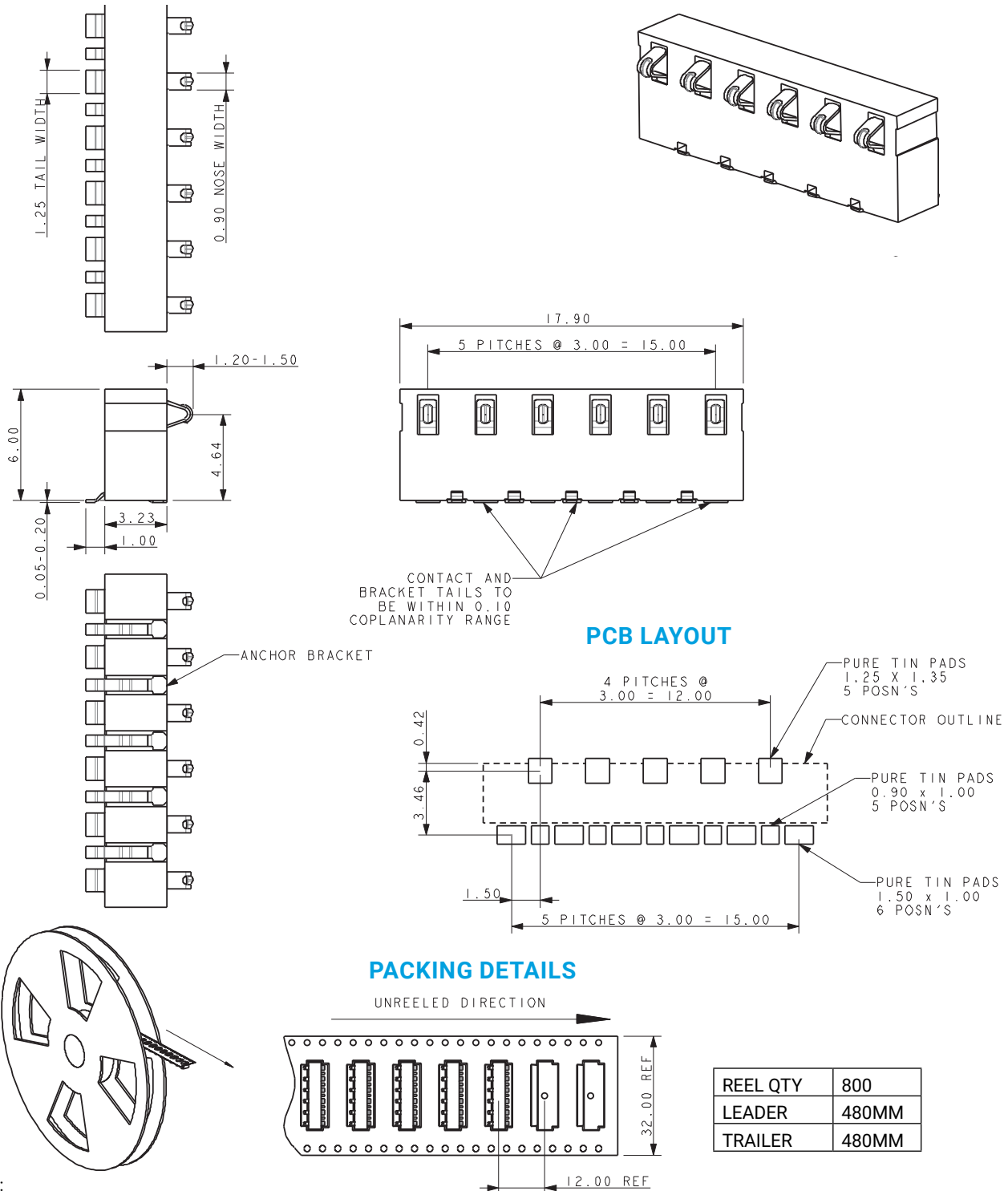

**NOTES:**

1. FOR MORE INFORMATION REFER TO PRODUCT SPEC 201-01-050.
2. GENERAL TOLERANCE  $\pm 0.20$  UNLESS OTHERWISE STATED.
3. FOR MATING PAD DETAILS REFER TO PAGE 29.
4. INSULATOR MATERIAL: 30% GLASS FILLED NYLON 46, UL94 V-O. COLOR BLACK.
5. CONTACT MATERIAL: BERYLLIUM COPPER.
6. CONTACT PLATING: SELECTIVE GOLD OVER NICKEL. PURE TIN ON TAILS.
7. BRACKET MATERIAL: PHOSPHOR BRONZE.
8. BRACKET PLATING: PURE TIN OVER NICKEL.

**RIGHT ANGLE BATTERY CONNECTOR – MATING PADS**

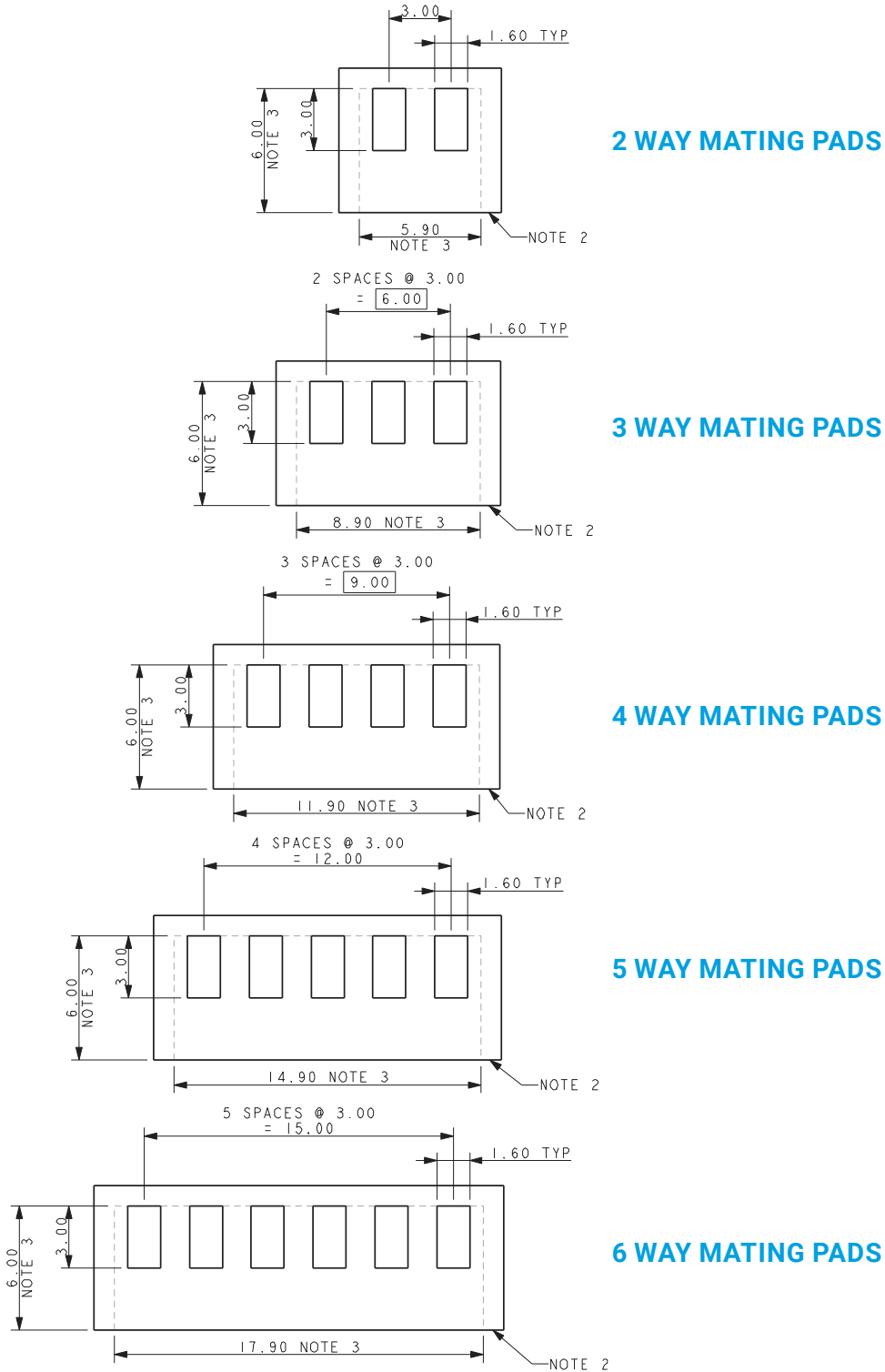

**NOTES:**

1. SUGGESTED MATING PADS FOR RIGHT ANGLE BATTERY CONNECTORS.
2. TOP SURFACE OF HORIZONTAL PCB/BASE OF CONNECTOR.
3. OUTLINE OF CONNECTOR.
4. PREFERRED PLATING ON PADS GOLD OVER NICKEL.