

SCM Series

Series-Connected SuperCapacitor Modules



This new series of electrochemical, double-layer, series-connected SuperCapacitor modules offers excellent pulse power handling characteristics based on the combination of very high capacitance and very low ESR. Used by themselves or in conjunction with primary or secondary batteries, they provide extended back up time, longer battery life, and provide instantaneous power pulses as needed. Offers great solutions to Hold Up, Energy Harvesting, and Pulse Power Applications.

FEATURES

- Low ESR provides high efficiency and high-power density
- Withstands high vibrations and high current applications
- Lifetime capable of millions of cycles
- Active cell balancing

APPLICATIONS

- Heavy Industrial Equipment
- Grid Storage
- Regenerative Energy Capture
- Pitch Control
- Energy Harvesting
- GSM/GPRS Pulse Applications
- UPS/Industrial

HOW TO ORDER

SCM	Z	85	P	836	S	T	A	B	2
Series SuperCap Module	Single Cell Diameter Z = 60mm	Single Cell Case Length Two digits represent case length in mm	Voltage Code P = 48V	Capacitance Code 836 = 83F	Tolerance S = +30% / -10%	Lead Format T = Line Post Lead Out	Package A = Aluminum Case	Balancing B = Balanced	Lead Orientation 2 = Bolt Lead Out

QUALITY INSPECTION

Parts are qualified for life cycle, high temperature load life, and storage temperature characteristics. See page 43 for more information.

TERMINATION

This module uses a 4 pin connector Pin 4 has a 10K NTC device connected between it and the ground. Reads resistance of the NTC to determine temperature. See page 44 for more information on each pin and resistance values at select intermediate temperatures.

OPERATING TEMPERATURE

Operating: -40°C to +65°C
Storage: -40°C to +70° (Uncharged)



For RoHScompliant products, please select correct termination style

SCM Series

Series-Connected SuperCapacitor Modules



RATINGS & PART NUMBER REFERENCES

Part Number	Case Width (mm)	Case Length (mm)	Capacitance (F)	Capacitance Tolerance	Rated Voltage (V)	Rated Temperature (°C)	DCL Max @ 72 Hrs (mA)	ESR Max @ 1000 Hz (mΩ)	ESR Max @ DC (mΩ)	Max Surge (V)	Peak Current (A)	Max Op. Current @ 40°C (A)	Max Energy (Wh)
SuperCap Module													
SCMZ85P836STAB2	194	418	83	+30% / -10%	48	65	3	-	9	51	1140	127	26.6

Additional Information

- Typical Weight: 9.5kg (±0.5)
- Insulation Resistance: ≥ 20MΩ
- Insulation Strength: ≤ 5.5mA
- Recommended Torque for Power Terminals:
M8 - 20Nm
M10 - 30Nm
- Overvoltage Monitoring: 52.2 ± 1.35V
- Passive Cell Voltage Management
- Cell Components – 18pcs of 2.7V 1500F, 60mm x 85mm

QUALIFICATION TEST SUMMARY

Test	Test Method	Parameter	Limits
Life Cycle	Capacitors are cycled between rated voltage and half-rated voltage under constant current at +25°C for 500,000 cycles	Capacitance ESR Appearance	≥70% of spec value ≤100% of spec value No remarkable defects
Temperature Characteristics	Temperature: -40°C to +65°C Voltage: Rated Voltage	Capacitance ESR Appearance	≥70% of spec value ≤100% of spec value No remarkable defects
Storage Temperature Characteristics	Storage Duration: 2 years No Load Temperature: +25°C ± 10°C	Capacitance ESR Appearance	≤10% of spec value ≤100% of spec value No remarkable defects
Vibration Resistance	IEC 60068-2-27, 29 / IEC 60068-2-6	Capacitance ESR Appearance	≥70% of spec value ≤100% of spec value No remarkable defects

SCM Series

Series-Connected SuperCapacitor Modules



QUALITY AND RELIABILITY

CAPACITANCE VS. TEMPERATURE

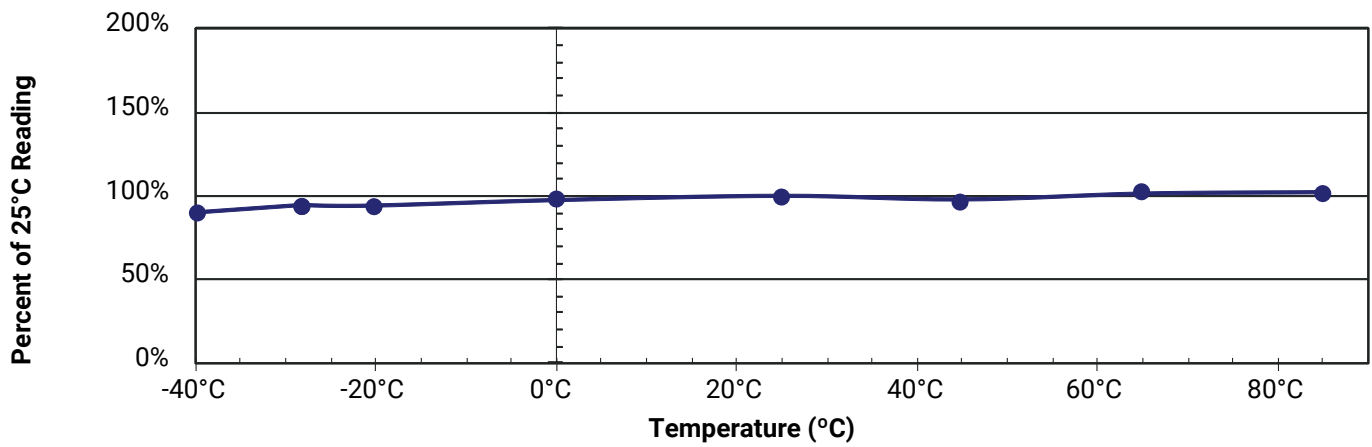

LEAKAGE CURRENT VS. TEMPERATURE

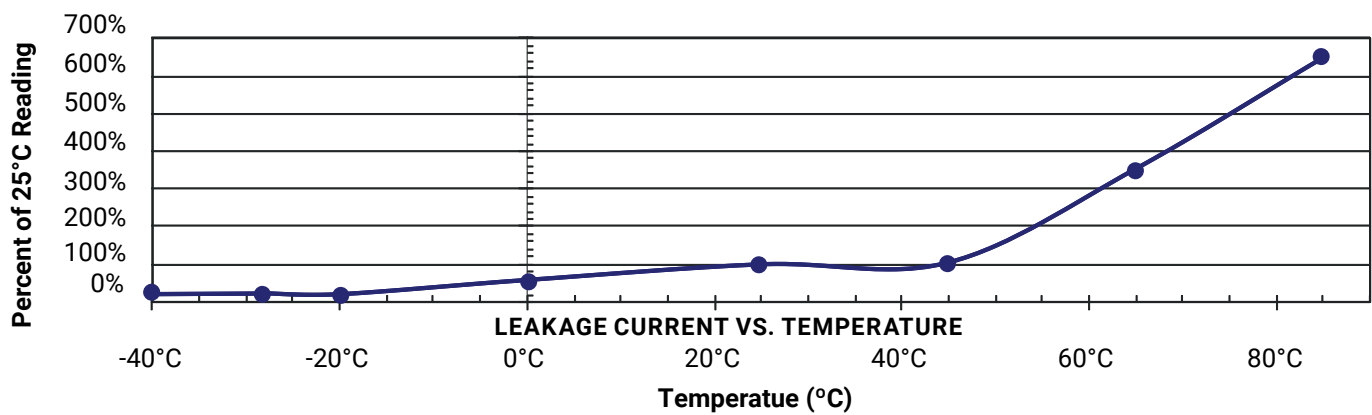

EQUIVALENT SERIES RESISTANCE VS. TEMPERATURE

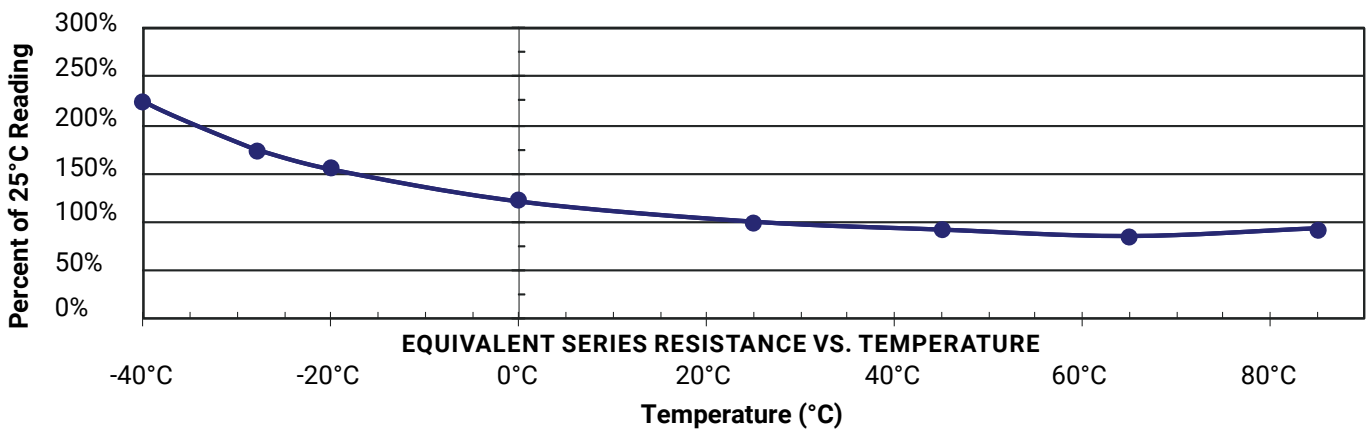

SCM Series

Series-Connected SuperCapacitor Modules

MECHANICAL SPECIFICATIONS

(All dimensions in mm)

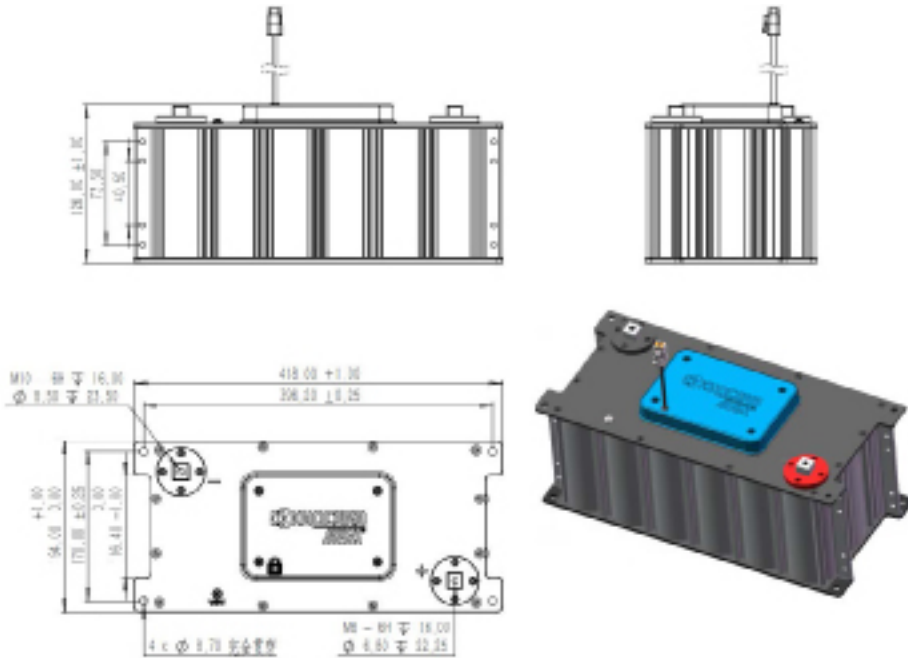

L (±1)	W (±1)	H (±1)	d (±0.05)	P (±0.8)
418	194	126	-	-

PIN INFORMATION

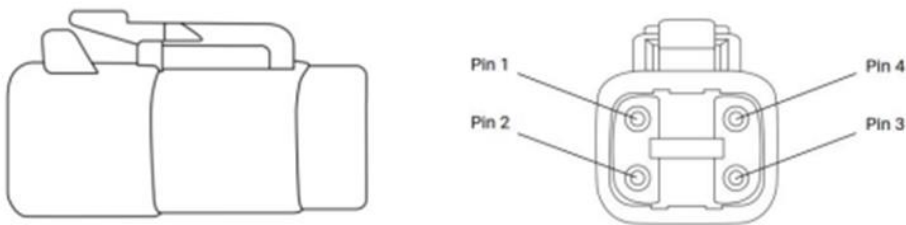

Pin	Color	Designation
1	White	Ground
2	Red	Overvoltage
3	Green	Not used
4	Yellow	Temperature

Temp (°C)	RT (o)
-40	332094
-25	129287
0	32554
25	10000
45	4372
65	2084
85	1070
100	677.3
125	338.7
150	182.6

SCM Series

Series-Connected SuperCapacitor Modules

TEST METHODS

IEC CAPACITANCE TEST METHOD

Procedure: Charge module under constant current to rated voltage at room temperature, then hold 10 minutes on charge under constant voltage. After 10 minutes, discharge under constant current (as shown in chart below), recording voltage at V_1 , V_2 , and time intervals at t_1 and t_2 . Use the capacitance formula to determine cap value.

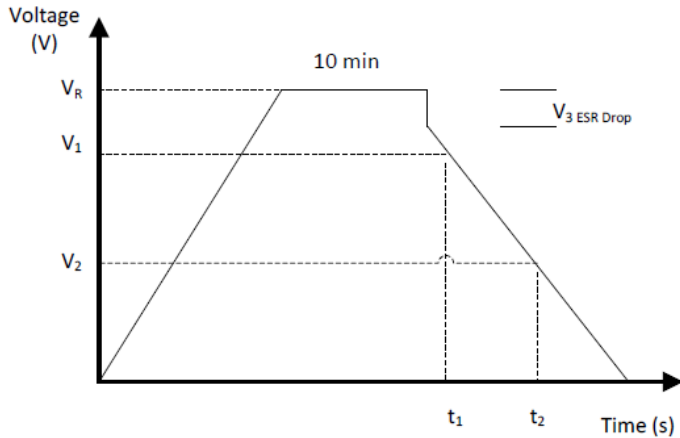

I – Discharge Current, $4 \times C \times V_R$ (mA)

V_R – Rated Voltage (V)

V_1 – Initial Test Voltage, 80% Of V_R (V)

V_2 – Final Test Voltage, 40% Of V_R (V)

t_1 – Initial Test Time (s)

t_2 – Final Test Time (s)

$$C = \frac{I \times (t_2 - t_1)}{V_1 - V_2}$$

DC ESR MEASUREMENT

A six-step ESR_{DC} test method is illustrated to the right and carried out as follows:

- Rest 10 Seconds
- Charge under constant current (I_1) to rated voltage (V_R)
- Rest 5 seconds
- Rest 10 seconds, record V_3 and t_4
- Discharge under constant current (I_2) to half rated voltage, Record I_2 , V_4 , And t_5
- Rest 2 seconds, record V_5 And t_6

Repeat steps 1-6 recording I , V , And t accordingly, finally discharging to below 0.1V under constant current (I_2).

Formulas to calculate:

• Two cycle discharge capacitances: $C_{dch1} = I_2 \times \frac{(t_5 - t_4)}{V_3 - V_4}$; $C_{dch2} = I_2 \times \frac{(t_{11} - t_{10})}{(V_9 - V_{10})}$

• Discharge capacitance: $C_{dch} = \frac{(C_{dch1} + C_{dch2})}{2}$

• Two cycle discharge DC ESR: $ESR_{dch1} = \frac{(V_5 - V_4)}{I_2}$; $ESR_{dch2} = \frac{(V_{11} - V_{10})}{I_2}$

• Discharge DC ESR: $ESR_{dch} = \frac{(ESR_{dch1} + ESR_{dch2})}{2}$

Note: $I_1 = I_2 = 75mA/F$, the rated capacitance in the chart means discharge capacitance, and DC ESR (ESR_{DC}) means discharge DC resistance.

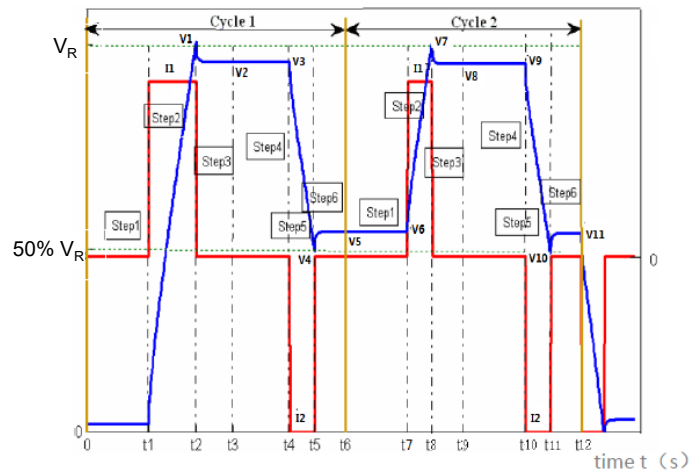

SCM Series

Series-Connected SuperCapacitor Modules

TEST METHODS (continued)

MAXIMUM CONTINUOUS CURRENT

- This is the maximum current when temperature rise of the supercapacitor during its operation is less than 15°C

MAXIMUM PEAK CURRENT

- This is the maximum current during 1 second time interval (dt)

WATT DENSITY

- Watt Density = $(0.12 \cdot V^2 / R_{DC}) / \text{mass}$

ENERGY DENSITY

- Energy Density = $(\frac{1}{2} CV^2) / (3600 \cdot \text{mass})$

POLARITY AND REVERSE VOLTAGE

For product consistency and optimum performance, it is recommended that the capacitor be connected with polarity indicated. Reversing polarity could result in permanent damage to the circuit including much higher leakage current for a short duration of time and the life time of the supercapacitors will be reduced.

LIFE TIME AND TEMPERATURE PERFORMANCE

The life of a supercapacitor is impacted by a combination of operating voltage and the operating temperature according to the following Time to Failure equation:

$$t \propto V^n \times e^{\left(\frac{-Q}{kT}\right)}$$

where V is the operating voltage, Q is the activation energy in electron volts (eV), k is the Boltzmann constant in eV, and T is the operating temperature in Kelvin (K). Typical values for the voltage exponent, n, is between 2.5-3.5, and Q is between 1.0-1.2 eV in the normal operating temperature range of -40° to 65°C.

The industry standard for supercapacitor end of life is when the equivalent series resistance, ESR, increases to 200% of the specified value and the capacitance drops by 30% from specified value. Typically a supercapacitor shows an initial “jump” in the ESR value and then levels off. If the supercapacitors are exposed to excessive temperatures the ESR will show a continuous degradation (increase). In the extreme case, if the temperature or voltage are substantially higher than the rated specifications, this could result in the part venting and the product showing a faster degradation of capacitance and ESR, which may be many times the specified value.

SCM Series

Series-Connected SuperCapacitor Modules



Expected Lifetime at Various Voltages
SCM Series

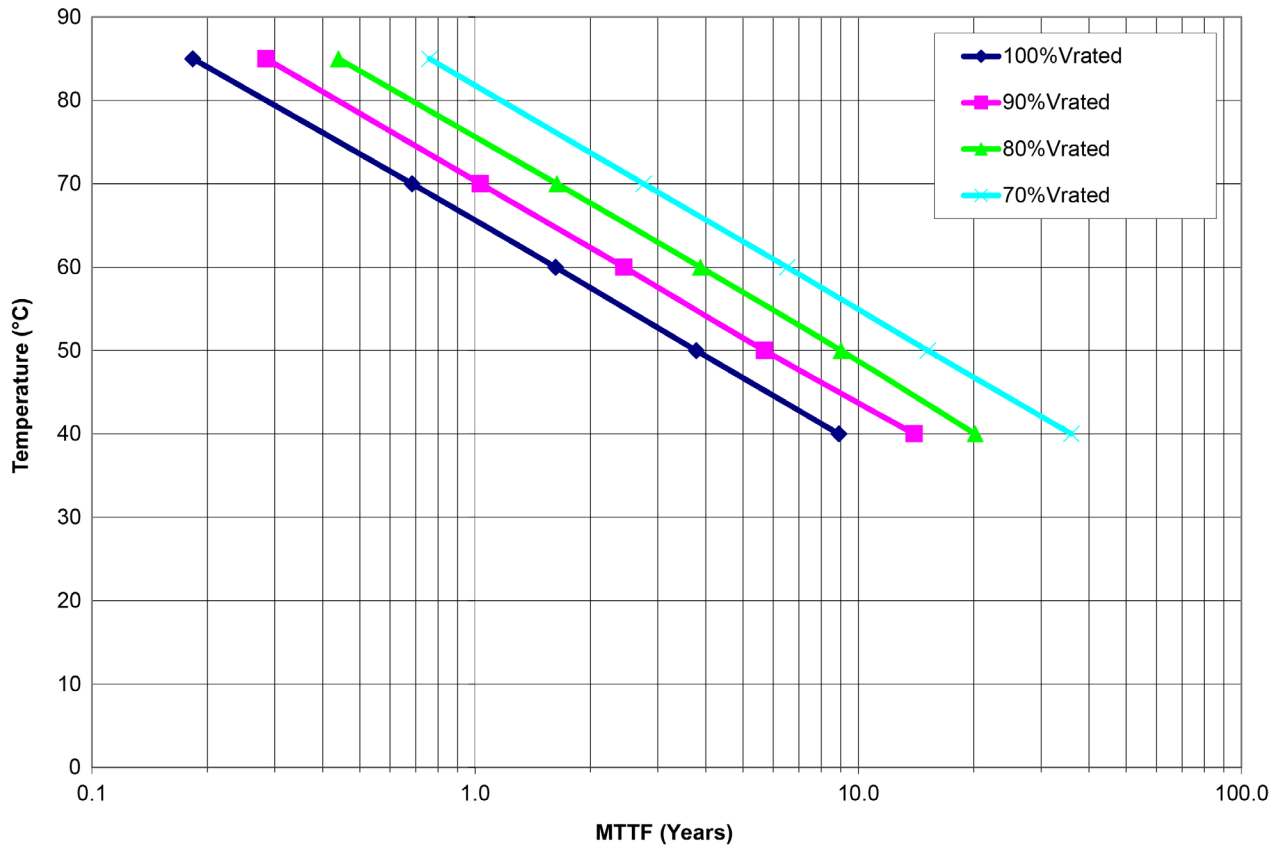

SAFETY RECOMMENDATIONS

WARNINGS

- To Avoid Short Circuit, after usage or test, Super Capacitor voltage needs to discharge to $\leq 0.1V$
- Do not Apply Overvoltage, Reverse Charge, Burn or Heat Higher than $150^{\circ}C$, explosion-proof valve may break open
- Do not Press, Damage or disassemble the Super Capacitor, housing could heat to high temperature causing Burns
- If you observe Overheating or Burning Smell from the capacitor disconnect Power immediately, and do not touch

EMERGENCY APPLICATIONS

- If Housing is Leaking:
- Skin Contact: Use soap and water thoroughly to wash the area of the skin
- Eye Contact: Flush with flowing water or saline, and immediately seek medical treatment
- Ingestion: Immediately wash with water and seek medical treatment

TRANSPORTATION

Not subjected to US DOT or IATA regulations
UN3499, <10Wh, Non-Hazardous Goods
International shipping description –
“Electronic Products – Capacitor”

REGULATORY

- RoHS Compliant
- REACH Compliant
- Halogen free according to IEC 61249-2-2: 2003 and IPC/JEDEC-JSTD-709

STORAGE

Capacitors may be stored within the temperature range of $-40^{\circ}C$ to $+70^{\circ}C$ with humidity $< 60\%$. Lower storage temperature is preferred as it extends the shelf life of the capacitor. Product over one year and within two years of the date code, we recommend recharging the product at the beginning of use for at least 24 hours.

Optimum storage conditions are as follows:

- $25^{\circ}C$ and $RH \leq 60\%$ without voltage applied
- Not in direct sunlight
- Not in direct contact with water, salt oil or other chemicals
- Not in direct contact with corrosive materials, acids, alkalis, or toxic gases
- Not in dusty environments
- Not in environments with shock and vibration conditions