

Part No. 1001435M0

Wi-Fi Dual Band On Ground / Off Ground Stamp Metal Antenna

2.4 / 5 GHz

Supports: Wi-Fi applications, Agriculture, Automotive, Bluetooth, Zigbee, WLAN, Smart Home, Healthcare, Digital Signage



KYOCERA AVX antennas deliver on the key needs of device designers for higher functionality and performance in smaller/thinner designs. These innovative antennas provide compelling advantages for a 2.4 GHz and 5 GHz enabled handheld devices, media players and other mobile devices. KYOCERA AVX antennas requires a smaller design keep-out area and yields a quicker time-to-market without sacrificing RF performance.

Greater Flexibility

KYOCERA AVX first-in-class technology enables you to develop concept designs that are more advanced and that deliver superior performance in reception critical applications.

Electrical Specifications

Typical Characteristics Free-space/ On Ground 150 x 150 mm PCB using 70 mm cable.

Wi-Fi Dual Band Stamp Metal Embedded Antenna

2.4 GHz; 5 GHz

KEY BENEFITS

Stay-in-Tune

KYOCERA AVX antenna technology provides superior RF field containment, resulting in less interaction with surrounding components.

Quicker Time-to-Market

By optimizing antenna size, performance and emissions, customer and regulatory specifications are more easily met.

Reliability

Products are the latest RoHS version compliant

APPLICATIONS

- Embedded design
- Cellular, Headsets, Tablets
- Gateway, Access Point
- Handheld
- Telematics Tracking
- Healthcare, M2M, Industrial devices
- Smart Grid
- OBD-II

Frequency	2400 – 2485 MHz		5150 – 5825 MHz	
Mounting	Off Ground	On Ground (Over Metal)	Off Ground	On Ground (Over Metal)
Peak Gain	4.2 dBi	4.7 dBi	6.4 dBi	6.0 dBi
Average Efficiency	82%	87%	80%	75%
VSWR Match	2:1 max			
Feed Point Impedance	50 ohms unbalanced			
Polarization	Linear			
Power Handling	0.5 Watt CW			

Mechanical Specifications & Ordering Part Number

Ordering Part Number	1001435M0
Size (mm)	41.1 x 14.6 x 9.7 (with Adhesive) 41.1 x 14.6 x 9.5 (no Adhesive, Drop-in)
Weight (grams)	~1.55
Cable/Connector (mm)	Length: 25, 50, 70, 75, 100, 150, 200 Diameter: 1.13, Color: Black; u.FI compatible connector
Mounting	1001435M0-AA10LXXXX (with Adhesive) 1001435M0-AA10LXXXXN (no Adhesive, Drop-in)

*Additional variations available with different cable lengths, colors and connectors.

2.4 / 5 GHz KYOCERA AVX Embedded Antenna Specifications
 KYOCERA AVX produces a wide variety of standard and custom antennas to meet user needs.

VSWR and Efficiency Plots (Off-Ground)

Typical Performance using 70 mm cable tested in Free-space

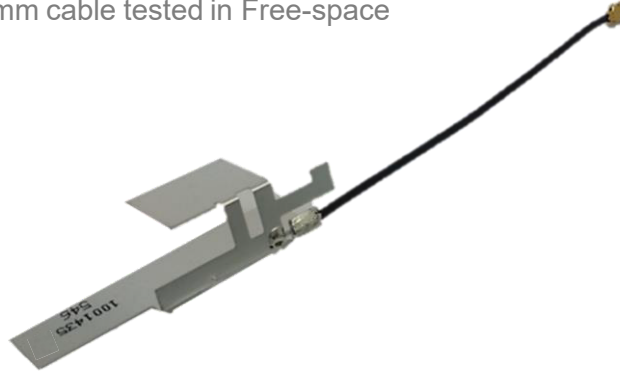

2.4 GHz VSWR

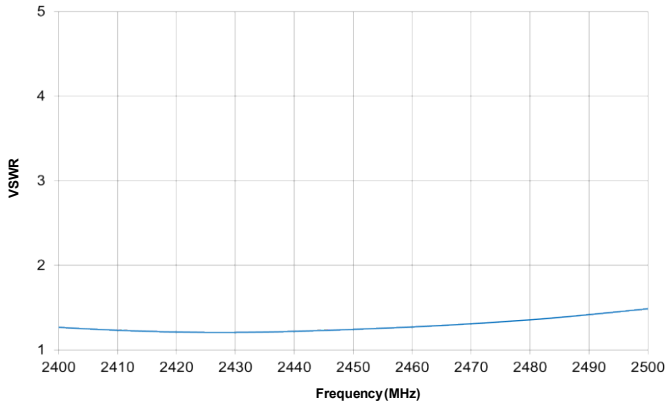

5 GHz VSWR

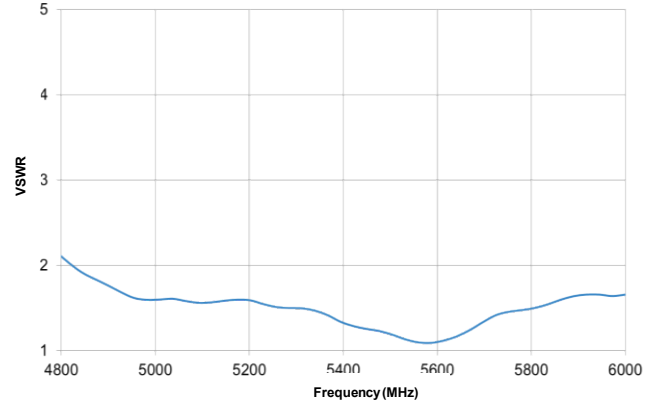

2.4 GHz Efficiency

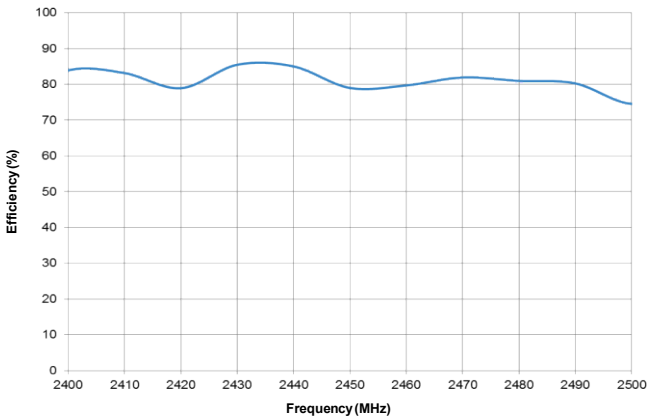

5 GHz Efficiency

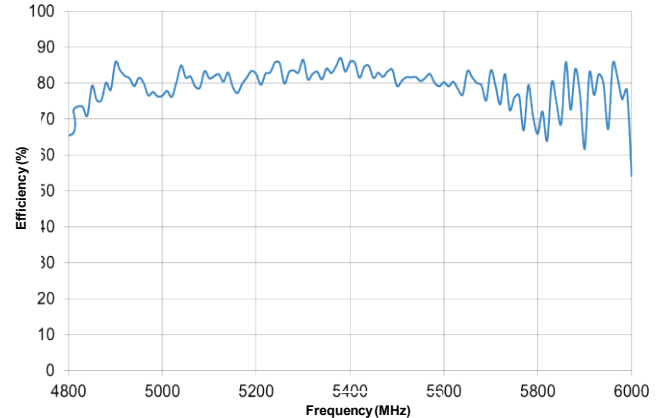

2.4 / 5 GHz KYOCERA AVX Embedded Antenna Specifications
 KYOCERA AVX produces a wide variety of standard and custom antennas to meet user needs.

Antenna Radiation Patterns (Off-Ground)

Typical Performance using 70 mm cable tested in Free-space

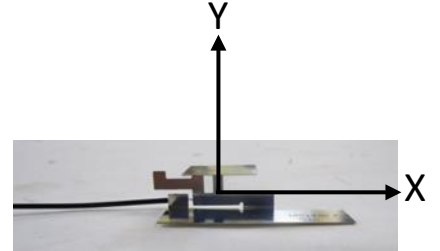
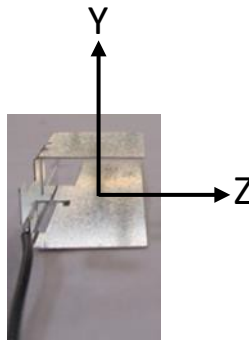
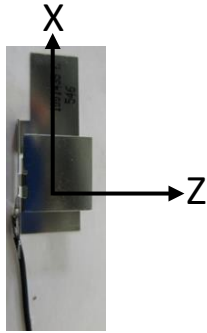

Measured at 2.45 GHz

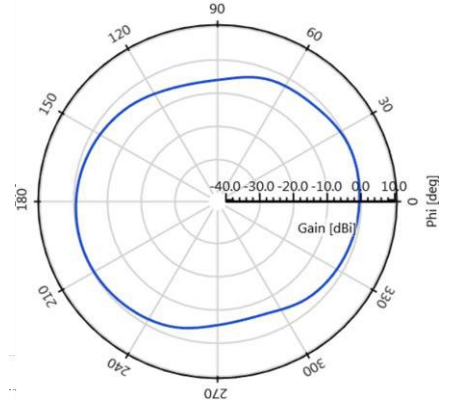
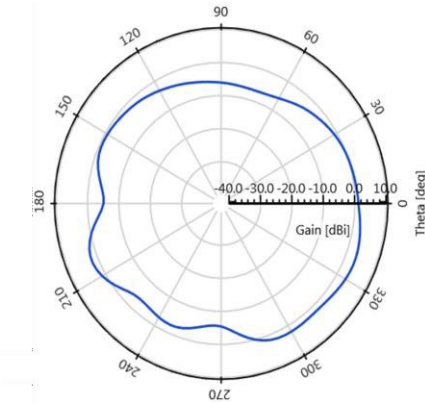
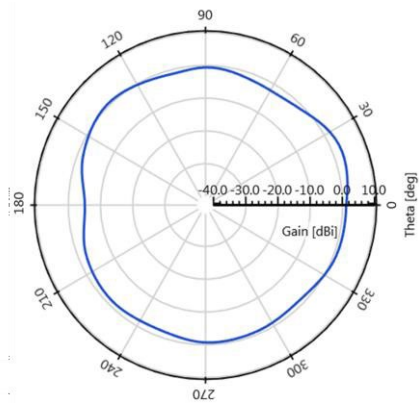

Measured at 5.4 GHz

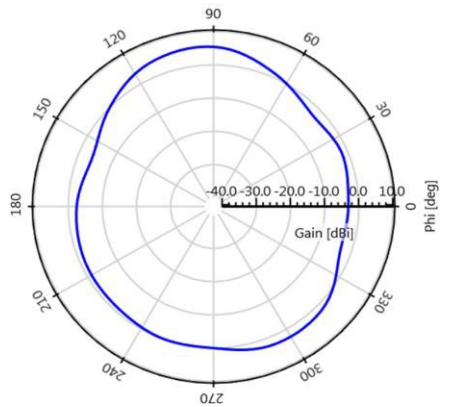
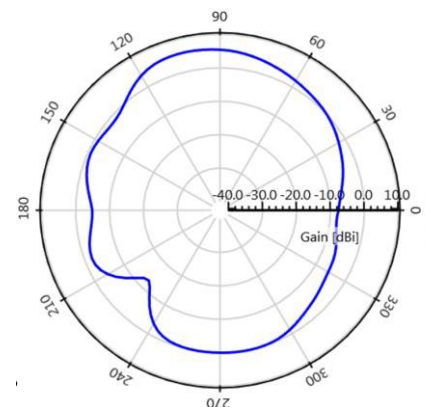
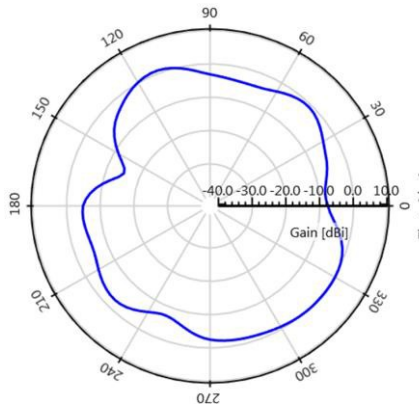

2.4 / 5 GHz KYOCERA AVX Embedded Antenna Specifications
 KYOCERA AVX produces a wide variety of standard and custom antennas to meet user needs.

VSWR and Efficiency Plots (On-Ground)

Typical performance using 70 mm cable tested in on 150 x 150 mm PCB

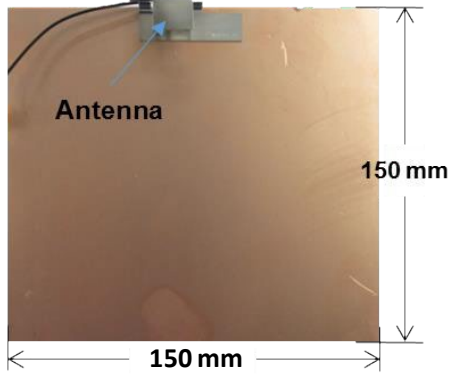

2.4 GHz VSWR

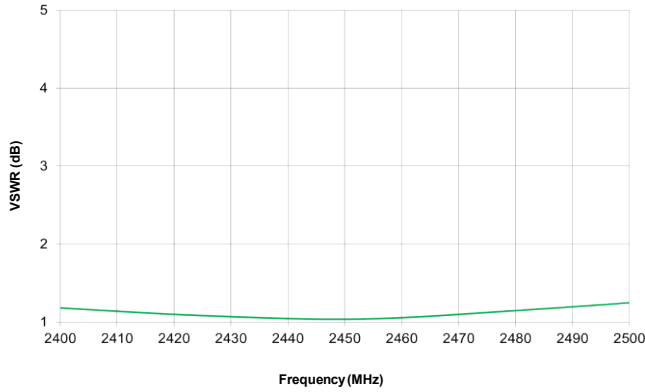

5 GHz VSWR

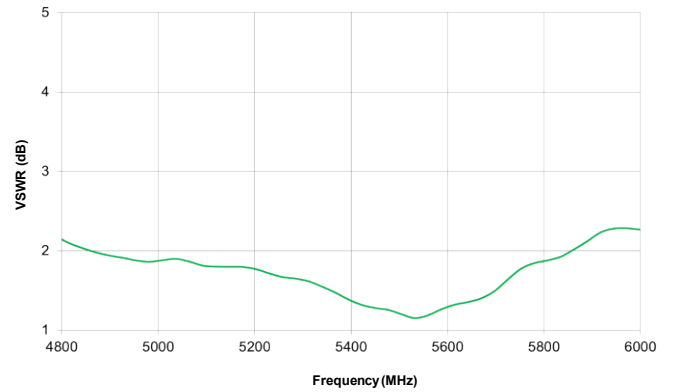

2.4 GHz Efficiency

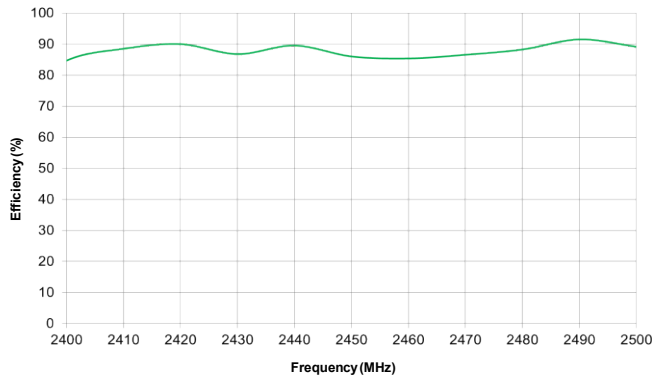

5 GHz Efficiency

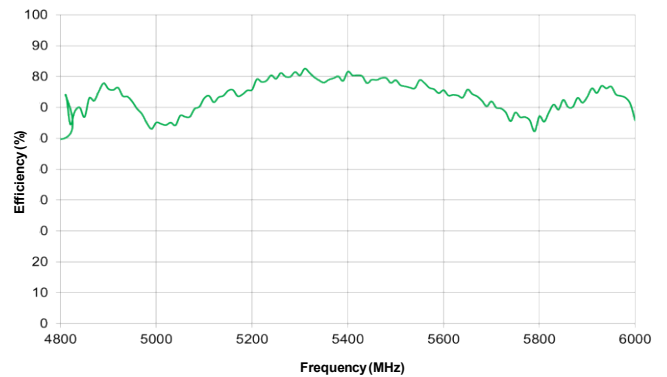

2.4 / 5 GHz KYOCERA AVX Embedded Antenna Specifications
 KYOCERA AVX produces a wide variety of standard and custom antennas to meet user needs.

Antenna Radiation Patterns (On-Ground)

Typical performance using 70 mm cable tested in on 150 x 150 mm PCB

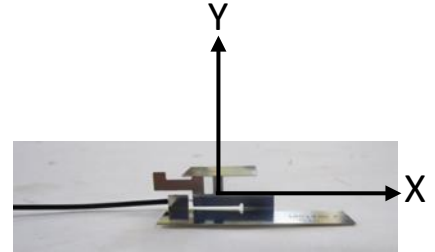
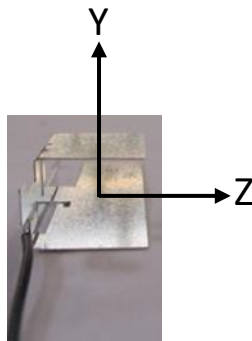
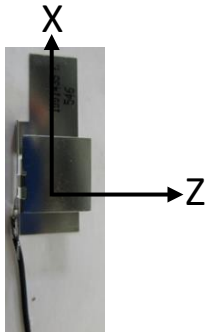

Measured at 2.45 GHz

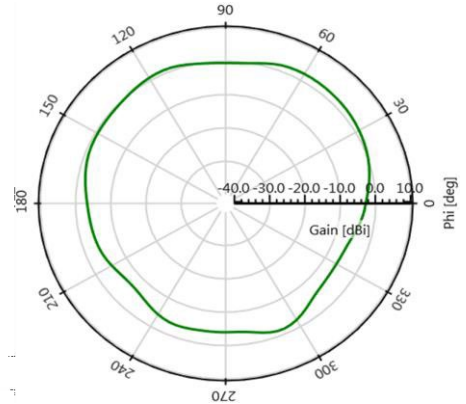
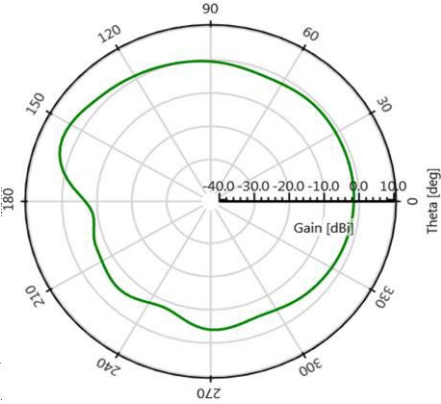
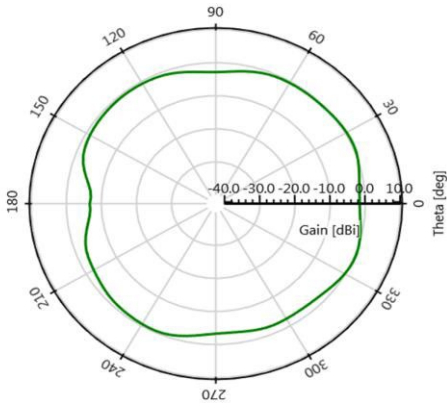

Measured at 5.4 GHz

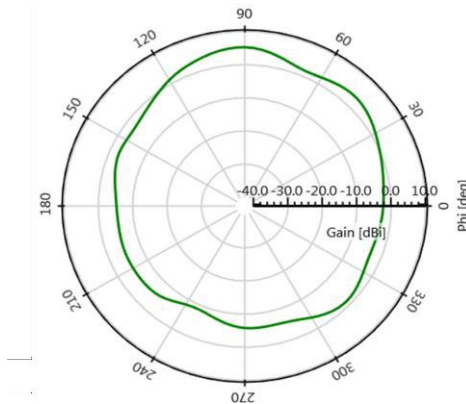
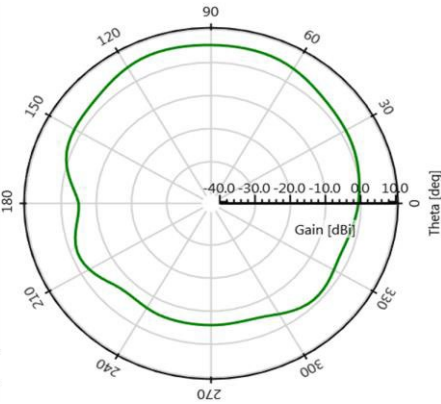
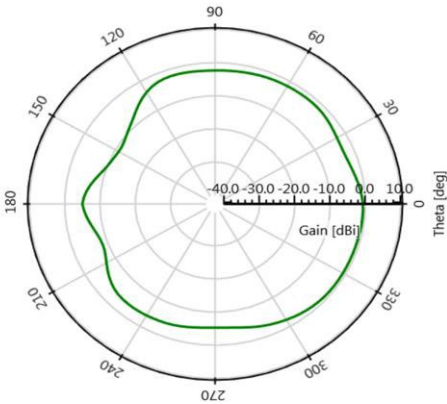

2.4 / 5 GHz KYOCERA AVX Embedded Antenna Specifications
 KYOCERA AVX produces a wide variety of standard and custom antennas to meet user needs.

Antenna Dimensions (with Adhesive)

Typical antenna dimensions, in mm.

Dimensions in () parenthesis are Reference Only.

Part Number	A	B	C	*D	Connector Type
1001435M0-AA10L0025	(41.1)	(14.6)	(9.7)	25.0 ± 3.0	MHF
1001435M0-AA10L0050	(41.1)	(14.6)	(9.7)	50.0 ± 3.0	MHF
1001435M0-AA10L0070	(41.1)	(14.6)	(9.7)	70.0 ± 3.0	MHF
1001435M0-AA10L0075	(41.1)	(14.6)	(9.7)	75.0 ± 3.0	MHF
1001435M0-AA10L0100	(41.1)	(14.6)	(9.7)	100.0 ± 3.0	MHF
1001435M0-AA10L0150	(41.1)	(14.6)	(9.7)	150.0 ± 4.0	MHF
1001435M0-AA10L0200	(41.1)	(14.6)	(9.7)	200.0 ± 4.0	MHF

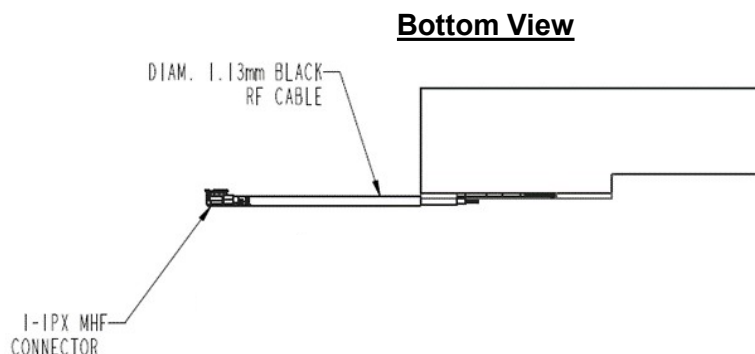
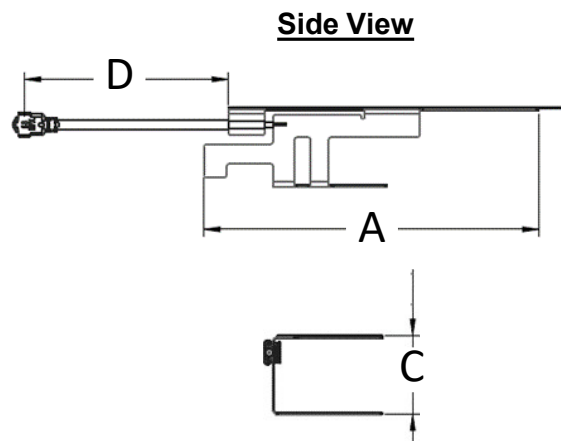
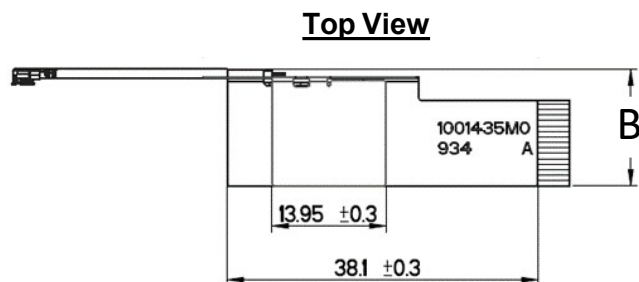

2.4 / 5 GHz KYOCERA AVX Embedded Antenna Specifications
 KYOCERA AVX produces a wide variety of standard and custom antennas to meet user needs.

Antenna Dimensions (no Adhesive, Drop-in)

Typical antenna dimensions, in mm.

Dimensions in () parenthesis are Reference Only.

Part Number	A	B	C	*D	Connector Type
1001435M0-AA10L0025N	(41.1)	(14.6)	(9.5)	25.0 ± 3.0	MHF
1001435M0-AA10L0050N	(41.1)	(14.6)	(9.5)	50.0 ± 3.0	MHF
1001435M0-AA10L0070N	(41.1)	(14.6)	(9.5)	70.0 ± 3.0	MHF
1001435M0-AA10L0075N	(41.1)	(14.6)	(9.5)	75.0 ± 3.0	MHF
1001435M0-AA10L0100N	(41.1)	(14.6)	(9.5)	100.0 ± 3.0	MHF
1001435M0-AA10L0150N	(41.1)	(14.6)	(9.5)	150.0 ± 4.0	MHF
1001435M0-AA10L0200N	(41.1)	(14.6)	(9.5)	200.0 ± 4.0	MHF

