

Part No. 1003468

Wi-Fi/ BT/ Zigbee Ceramic Patch 2.4 GHz Antenna

2.4 GHz

Supports: Wi-Fi, Bluetooth, Zigbee, Matter



The Ceramic Patch 1003468 offers all the advantages of a circular polarized 2.4GHz antenna in a small factor, easy to integrate to all the embedded designs requiring high performances and long range

Ceramic Wi-Fi / BT / Patch Antenna

2400 – 2485 MHz

KEY BENEFITS

Reduced Costs and Time-to-Market

Standard antenna eliminates design fees and cycle time associated with a custom solution; getting products to market faster.

Quicker Time-to-Market

By optimizing antenna size, performance and emissions, customer and regulatory specifications are more easily met.

Environmental Compliance

Products are the latest RoHS version compliant.

APPLICATIONS

- Embedded design
- POS, Headsets, Tablets
- Gateway, Access Point
- Handheld
- Telematics
- Tracking
- M2M, Industrial devices
- Smart Grid
- OBD-II

Electrical Specifications

Typical characteristics, measured on a 50 x 50 mm PCB ground plane.

Frequency (GHz)	2.400 – 2.485
Peak Gain	3.83 dBi
Average Efficiency	74%
VSWR Match	2:1 max
Polarization	Circular RHCP
Feed Point Impedance	50 Ohms unbalanced

Mechanical Specifications & Ordering Part Number

Ordering Part Number	1003468
Size (mm)	18.0 x 18.0 x 4.0
Mounting (mm)	Back adhesive and pin
Weight (grams)	4.8
Packaging	Plastic Tray
Additional Resources	Download DXF, Gerber and 3D FIT Files

2.4 GHz Ceramic Patch Antenna Specifications
 KYOCERA AVX produces a wide variety of standard and custom antennas to meet user needs.

VSWR and Efficiency Plots

Measured on a 50 x 50 mm ground plane

VSWR

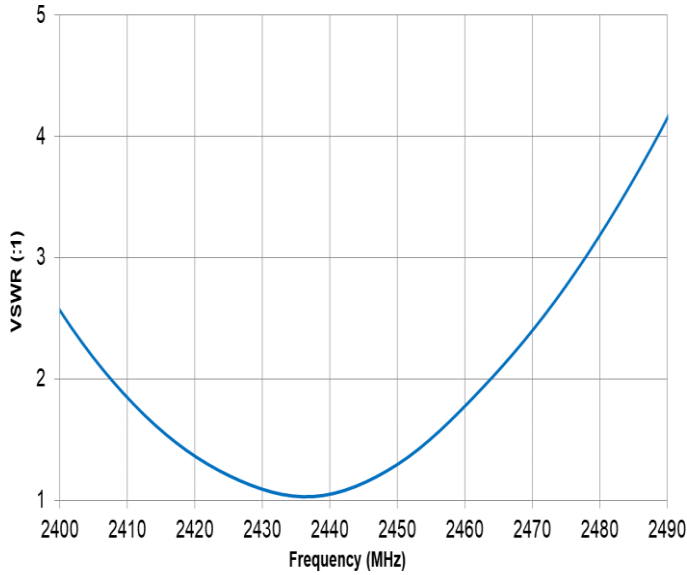

Efficiency

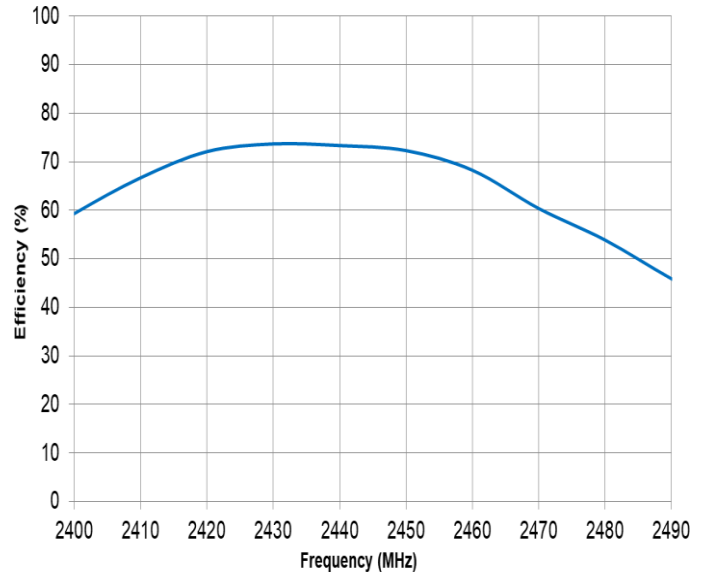

Antenna radiation patterns

Measured on a 50 x 50 mm ground plane

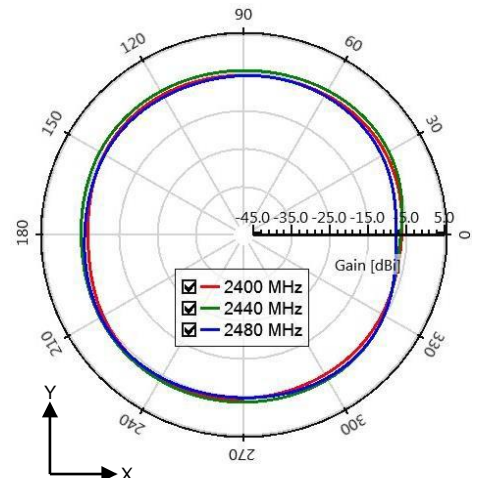
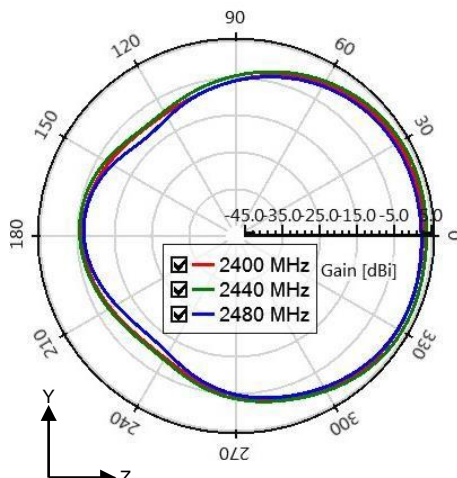
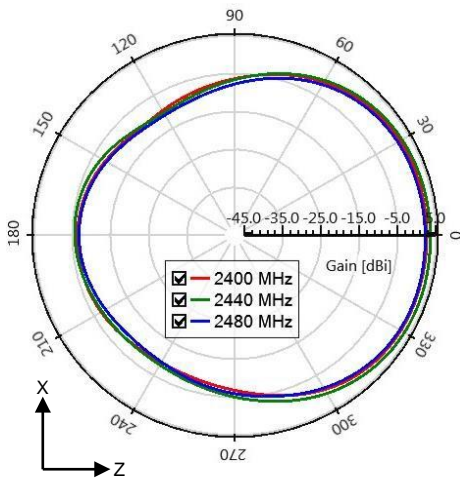
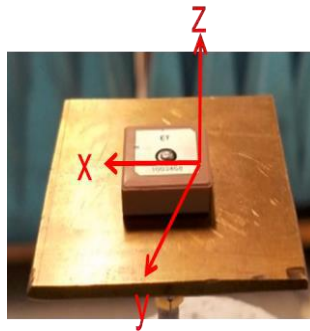

2.4 GHz Ceramic Patch Antenna Specifications
 KYOCERA AVX produces a wide variety of standard and custom antennas to meet user needs.

Antenna Layout

Typical antenna dimensions, in mm.

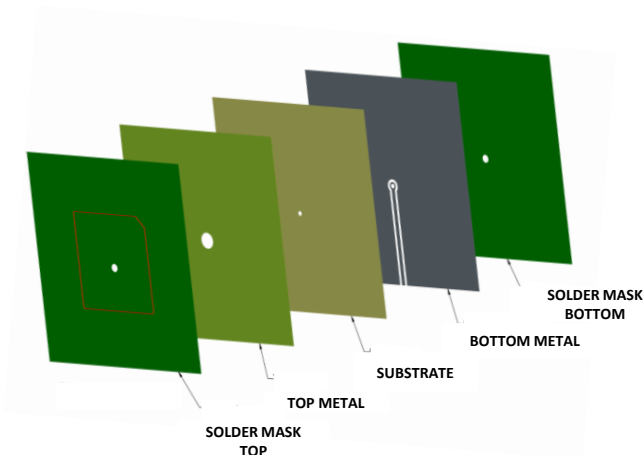

BOARD LAYOUT-01

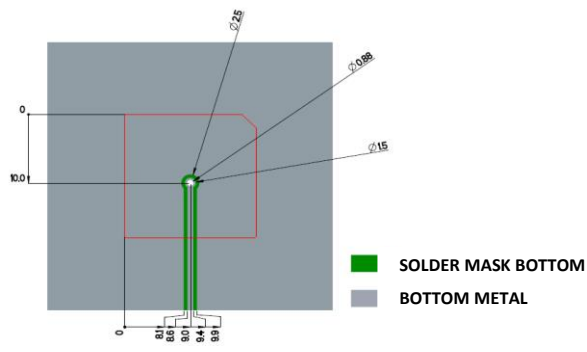
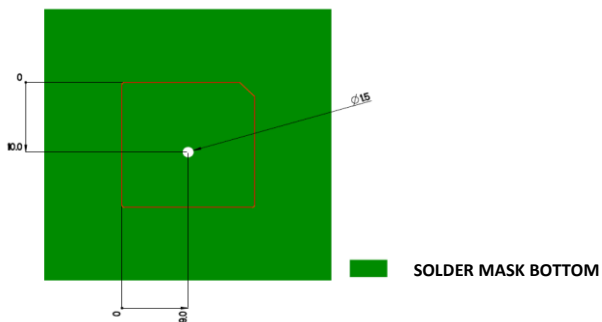
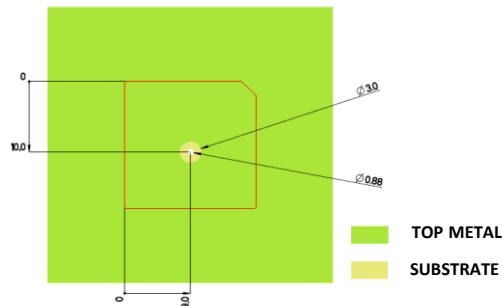
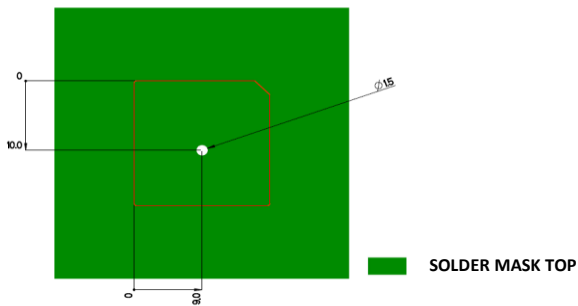

2.4 GHz Ceramic Patch Antenna Specifications
 KYOCERA AVX produces a wide variety of standard and custom antennas to meet user needs.

Mechanical Dimensions

Typical antenna dimensions, in mm.

Part Number	A (mm)	B (mm)	C (mm)
1003468	18.0 ± 0.2	18.0 ± 0.2	4.0 ± 0.2

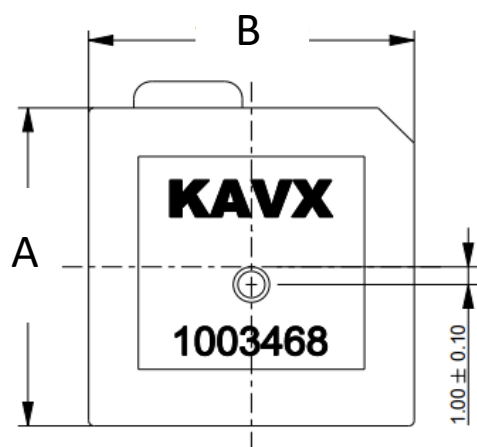

Top View

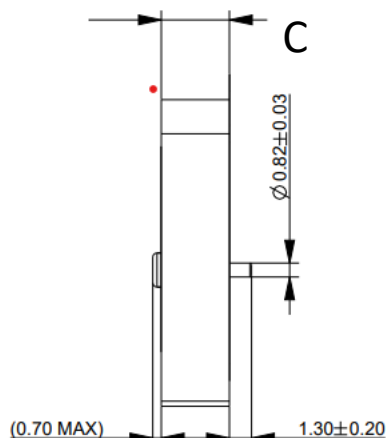

Side View

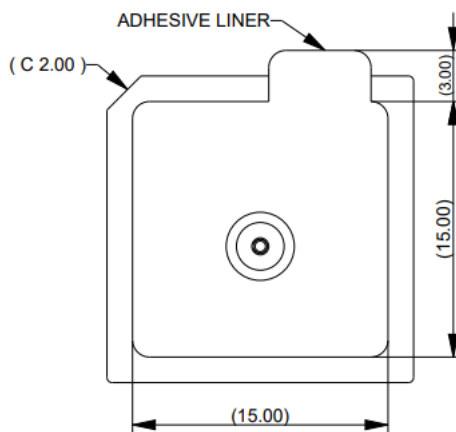

Bottom View

2.4 GHz Ceramic Patch Antenna Specifications
KYOCERA AVX produces a wide variety of standard and custom antennas to meet user needs.

Additional Resources - 1003468

3D FIT File:

https://www.kyocera-avx.com/download/antennas/ME-FIT/1003468_ME_fit.zip

DXF File:

https://www.kyocera-avx.com/download/antennas/3D-DXF/1003468-01_3D-DXF.zip

Gerber File:

https://www.kyocera-avx.com/download/antennas/GERBER/1003468-01_GERBERS.zip