

# Power Capacitor Assemblies

## Overview

### ABOUT KYOCERA AVX POWER ASSEMBLIES

KYOCERA AVX standard & custom Power Assemblies are fabricated from PARALLEL and SERIES combinations of industry-respected KYOCERA AVX catalog products. Customer requirements are addressed by a variety of computer matching and assembly techniques which have enabled KYOCERA AVX to extend voltage, current, ESR, Q, and tolerance parameters beyond what is normally available in the industry.

KYOCERA AVX Power Assemblies offer distinct advantages over purchasing standard components “in the general ballpark” and trying “hit & miss” approaches to configure & match these in a circuit environment. KYOCERA AVX’s strong tradition of quality and customer service enables us to work closely with design engineers to meet critical specifications.

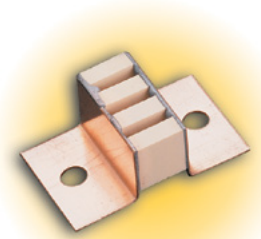

### PERFORMANCE ADVANTAGES

- High Operating Voltage
- High Operating Current
- Extended Capacitance
- Tighter Tolerances
- High Reliability
- High Q
- Ultra-low ESR

### TYPICAL APPLICATIONS

- High Power RF
- Medical Electronics
- Broadcast
- Industrial Applications
- Semiconductor Manufacturing
- High Magnetic Environments
- Inductive Heating

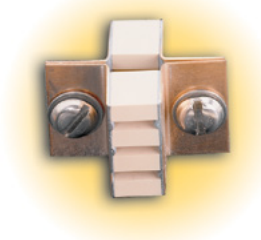

### BENEFITS OF UTILIZING POWER ASSEMBLIES

- **New price structure allows for more cost-effective assemblies.**
- **Reduced Assembly Steps / Handling Costs:**  
Combinations of capacitors pre-packaged in manageable mechanical configurations for customer specific “drop-in” applications – Fits Every Time.
- **Enhanced Reliability:**  
Overall elements and assemblies are 100% pre-tested to customer’s electrical requirements:  
– Capacitance – Q – IR – DWV (to 10kV max).
- **Reduced Purchasing Logistics:**
  - Reduced inventory requirements in matched assemblies
  - Elimination of excess, wasted parts
- **Reduced Technical Labor:**  
Alleviate need for engineering and technician resources in selecting electrically matched elements.
- **Guaranteed Performance:**  
KYOCERA AVX guarantees electrical / mechanical performance on an assembly level every time.
- **Achieve Non-Standard Values and Ultra-Tight Tolerances:**  
KYOCERA AVX will “mix and match” values from our extensive inventory via computer matching programs to achieve any capacitor value specified by the designer.

KYOCERA AVX’s products provide many advantages to customers requiring multiple component capacitive sets and assemblies

Call KYOCERA AVX – or your Local KYOCERA AVX representative to reach one of our Power Assembly Applications

# Power Capacitor Assemblies

## Capabilities

KYOCERA AVX offers both standard designs and custom products, including matched sets and voltage dividers. KYOCERA AVX Power Assemblies are available in two categories: Standard and Custom.

### STANDARD ASSEMBLIES

Are those configurations most frequently specified by customers. Although it is not possible to stock finished assemblies, fabrication time is short, as the lead configurations and necessary tooling are readily available.

### CUSTOM ASSEMBLIES

For those instances where our Standard Assemblies cannot be used, KYOCERA AVX will assist in the design of special configurations to meet customer needs. Special capacitor groupings and lead configurations can be provided to customer configurations.

### NON-MAGNETIC ASSEMBLIES

To maintain assembly performance in high magnetic field environments, KYOCERA AVX provides a catalog option for termination materials with magnetic immunity.

### MATCHED SETS

For designs that require close tolerance non-standard capacitance values, KYOCERA AVX offers parallel or series sets to match 2 or more capacitors to the exact value required.

### VOLTAGE DIVIDERS

For those designs requiring capacitive voltage dividers, KYOCERA AVX can provide a set of capacitors that will satisfy

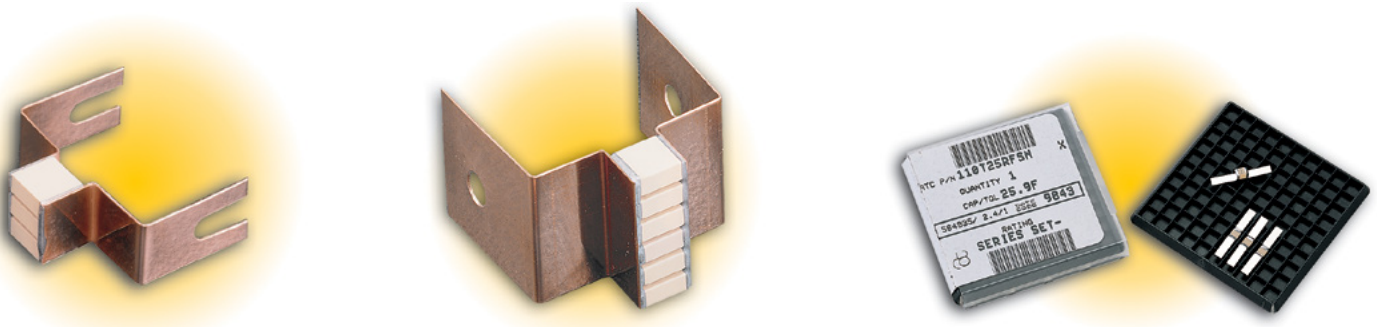

# Power Capacitor Assemblies

## Assemblies

### TYPICAL MECHANICAL CONFIGURATION

The following configurations represent frequently ordered catalog assemblies offered by KYOCERA AVX. The drawings depict a variety of mounting configurations, circuit attachment options and series/parallel combinations.

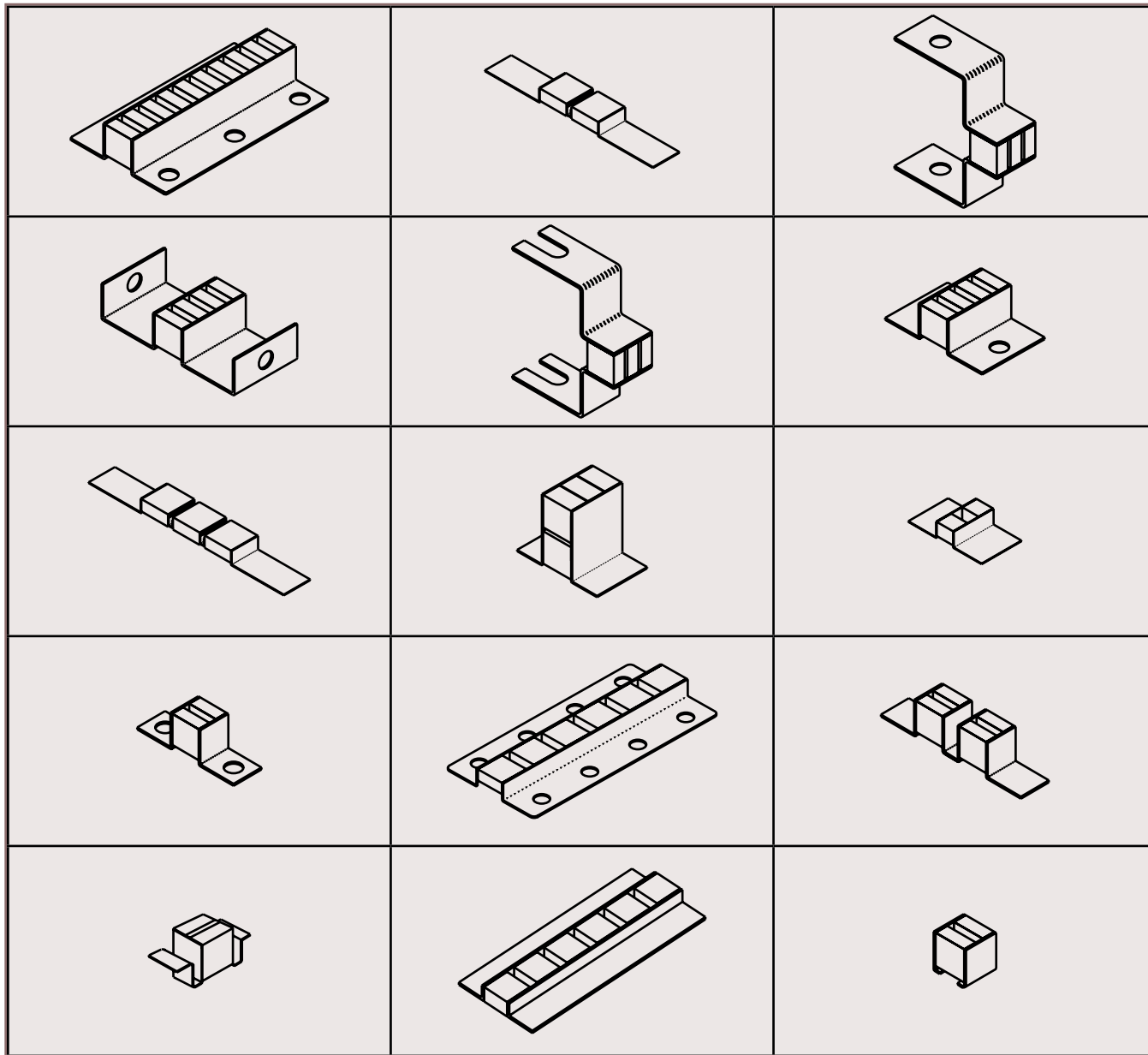

### CUSTOM PACKAGING

KYOCERA AVX's **Applications Engineering** and **Mechanical Engineering** personnel are available to support your specific packaging needs.

# Power Capacitor Assemblies

## Assemblies

### STANDARD ASSEMBLY CONFIGURATIONS

KYOCERA AVX offers leaded assemblies that extend the capacitance, voltage and current parameters of our standard multilayer ceramic product line. As our standard products are the building blocks for each assembly, KYOCERA AVX's proven reliability, electrical and mechanical parameters become part of each assembly.

Assemblies of parallel grouped capacitors not only increase the capacitance but will exhibit ultra-low ESR. Assemblies of series grouped capacitors will allow both tighter tolerances and higher working voltages. Combinations of Parallel and Series assemblies can realize an increase in both capacitance and voltage rating. Assemblies can be composed of multiple capacitors in horizontal, vertical or multi-level mounting configurations.

All leaded assemblies are RoHS compliant.



### PARALLEL ASSEMBLIES

Standard Design Parameters	B Case	C Case	E Case
No. of caps	2	2 - 6	2 - 8
Lead Type	L Bracket	L Bracket	L Bracket
Lead Materials	Silver	Silver	Silver or Copper
Lead Thickness	.004 or .010 (0.10 or 0.25)	.004 or .010 (0.10 or 0.25)	.010 or .020 (0.25 or 0.51)
Lead Length (max.)	0.5 (12.7)	0.75 (19.1)	2.0 (50.8)
No. Holes (max.)	None	1 per lead	1 per lead
Mtg Configuration	Horizontal/Vertical	Horizontal/Vertical	Horizontal/Vertical
Capacitor Spacer (typ.)	.050 or .070 (1.27 or 1.78)	.050 or .070 (1.27 or 1.78)	.090 (2.29)

inches (mm)

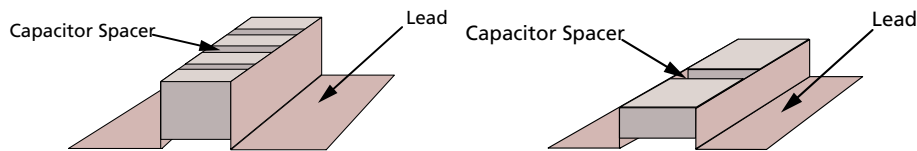

### SERIES ASSEMBLIES

Standard Design Parameters	C Case	E Case
No. of caps	2 - 3	2 - 3
Lead Type	L Bracket	L Bracket
Lead Materials	Silver	Silver
Lead Thickness	.010	.010
Lead Length (max.)	0.75 (19.1)	1.0 (25.4)
No. Holes (max.)	1 per lead	1 per lead
Mtg Configuration	Horizontal	Horizontal
Capacitor Spacer (typ.)	.050 (1.27)	.050 (1.27)

inches (mm)

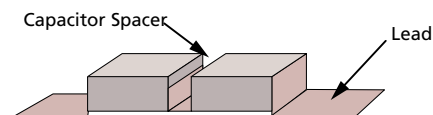

# Power Capacitor Assemblies

## Part Number Code

### KYOCERA AVX POWER ASSEMBLY PART CODE

The part number consists of a base description plus an KYOCERA AVX drawing number. The final design will be based on customer requirements. All leaded assemblies are RoHS compliant

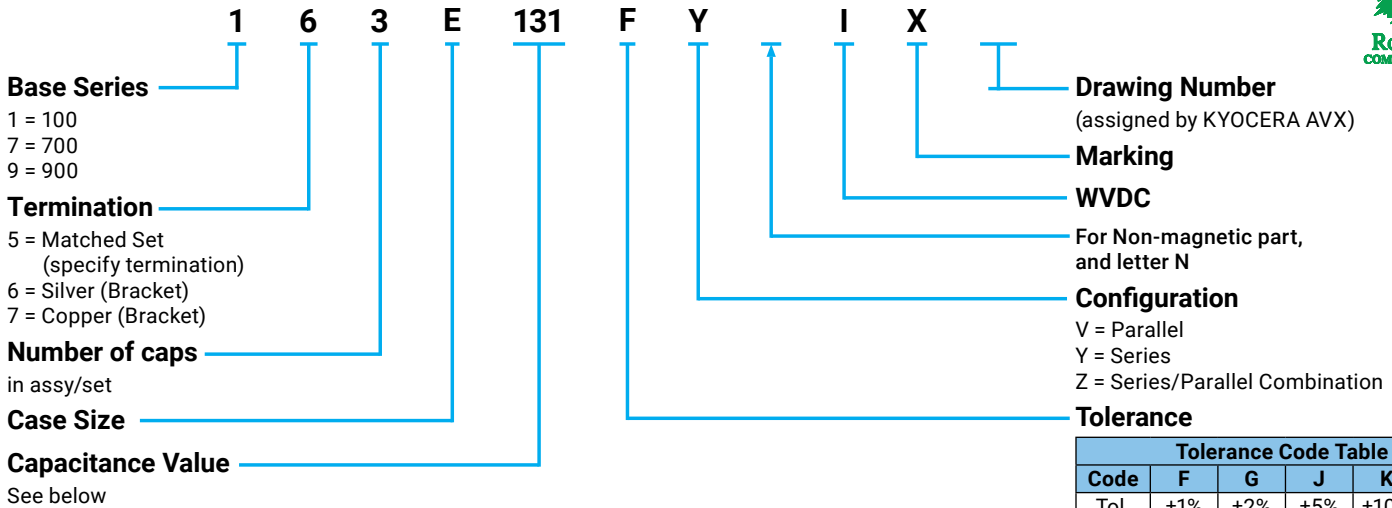

### CAPACITANCE VALUE:

**For capacitor values requiring only 2 significant digits:**

3 digit code consists of 2 significant digits and a multiplier. The R is used for decimal values.

e.g. 172E151JVQX-1103D

Copper bracket assembly with two 100E pieces in parallel, with an end value of 150 pF, ±5% tolerance, 3600 WVDC, and marked with part number code.

**For capacitor values requiring 3 significant digits:**

3 digit code consists of first two significant digits and the third consisting of a letter representing the values 1 to 9.

e.g. 163E13EFYN\*X-1028A

A = 1, B = 2, C = 3, D = 4, E = 5, F = 6, G = 7, H = 8, J = 9

Silver bracket assembly with three 100E pieces in series, non magnetic with an end value of 135 pF, ±1% tolerance, 10200 WVDC.

**For capacitor values requiring more than 3 significant digits:**

The capacitance code consists of the two most significant digits and an X, where "X" is separately defined.

e.g. 176E23XKVV-1447A

Copper bracket assembly with six 100E pieces in parallel, with an end value specified separately on the order. In this case it could be 2340 pF, ±10% tolerance, 2500 WVDC, and no marking.

### VOLTAGE RATING CODES

Code	5	1	E	2	V	9	7	C	4	A	S	G	W	H	Q	K	I	*
<b>Voltage (V)</b>	50	100	150	200	250	300	500	600	800	1000	1500	2000	2500	3000	3600	5000	7200	Non-Std

# Power Capacitor Assemblies

## Configurations and Special Test Options

### CUSTOM ASSEMBLIES

For those requirements that can not be satisfied using standard assemblies, KYOCERA AVX offers custom designed assemblies. Special capacitor groupings, lead configurations and hole size/spacing can be supplied to meet customers' unique requirements. Consultation with the KYOCERA AVX Applications Engineering staff will ensure the selection of the proper capacitors for the job provided at a reasonable cost.

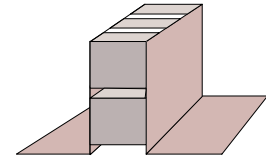

Example of 3 over 3 vertical mount construction.

### MATCHED SETS: SERIES OR PARALLEL CONFIGURATIONS

For customers requiring non-standard values or very close tolerance capacitance values, we can select a set of capacitors (2 or more) to achieve the desired results. The following tolerances are available:

Series	Capacitance Range	Tolerance
<b>*100A/700A</b>	1 pF to 6.2 pF 6.8 pF to 1000 pF	0.1 pF 0.5%
<b>100B/700B</b>	1 pF to 6.2 pF 6.8 pF to 1000 pF	0.1 pF 0.5%
<b>100C</b>	1 pF to 2700pF	0.5%
<b>100E</b>	1 pF to 5100 pF	0.5%

\*See complete KYOCERA AVX Catalog for specifications

### VOLTAGE DIVIDERS

Voltage dividers based on capacitive reactance can be provided to customers' specific capacitance ratio. Ratios can be provided within 1.0%. An example of a 10 to 1 ratio is shown below:

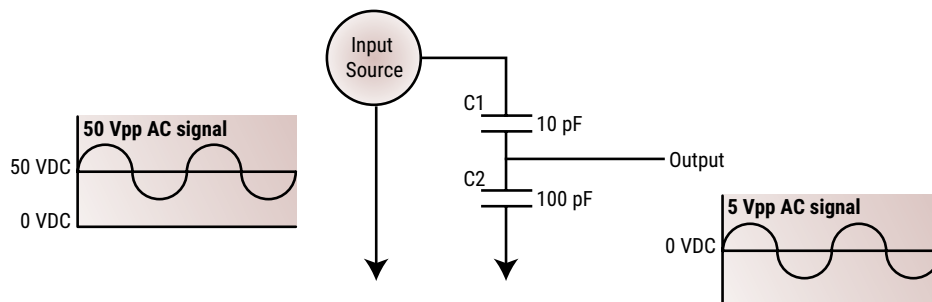

### SPECIAL TEST OPTIONS

- For high reliability requirements, KYOCERA AVX can provide enhanced screening of the individual capacitors that comprise each assembly.

# Power Capacitor Assemblies

## Individual Capacitor Specifications for Power Capacitor Assemblies

### 100 B SERIES PORCELAIN SUPERCHIP® MULTILAYER CAPACITOR

<b>Capacitance Range</b>	0.1 pF to 1000 pF
<b>Quality Factor (Q)</b>	Greater than 10,000 at 1 MHz
<b>Temperature Coefficient of Capacitance (T.C.)</b>	+90 ±20 PPM/°C (-55°C to +125°C) +90 ±30 PPM/°C (+125°C to +175°C)
<b>Insulation Resistance (IR)</b>	0.1 pF to 470 pF: 10 <sup>6</sup> Megohms min. @ +25°C at rated WVDC 10 <sup>5</sup> Megohms min. @ +125°C at rated WVDC 510 pF to 1000 pF: 10 <sup>5</sup> Megohms min. @ +25°C at rated WVDC 10 <sup>4</sup> Megohms min. @ +125°C at rated WVDC IR above +125°C is derated by one order of magnitude
<b>Working Voltage (WVDC)</b>	Up to 1500 WVDC See Capacitance Values Table, KYOCERA AVX 100B datasheet

<b>Dielectric Withstanding Voltage (DWV)</b>	See KYOCERA AVX 100B Series Datasheet
<b>Retrace</b>	Less than ±(0.02% or 0.02 pF), whichever is greater
<b>Aging Effects</b>	None
<b>Piezoelectric Effects</b>	None (No capacitance variation with voltage or pressure)
<b>Capacitance Drift</b>	±(0.02% or 0.02 pF), whichever is greater

## PERFORMANCE DATA

**ESR VS CAPACITANCE  
SERIES 100, CASE B**

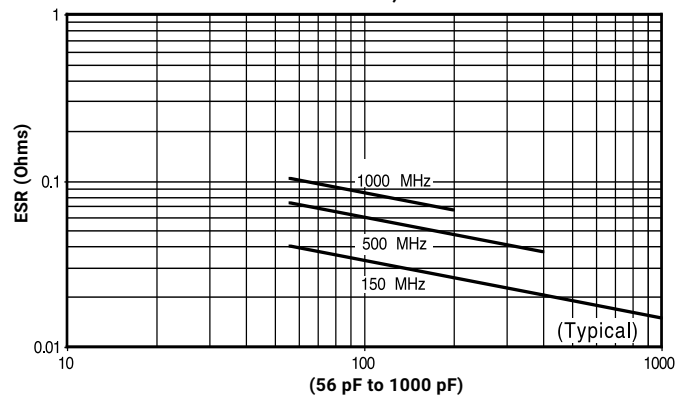

**CURRENT RATING VS CAPACITANCE  
SERIES 100, CASE B, EXTENDED VOLTAGE**

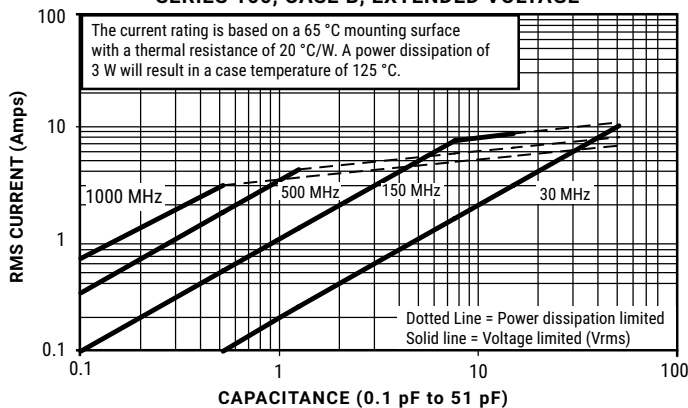

**CURRENT RATING VS CAPACITANCE  
SERIES 100, CASE B, EXTENDED VOLTAGE**

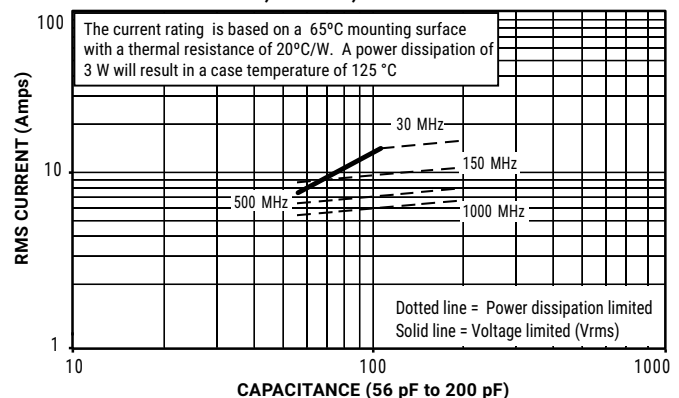

# Power Capacitor Assemblies

## Individual Capacitor Specifications for Power Capacitor Assemblies



### 100 C SERIES PORCELAIN HIGH RF POWER MULTILAYER CAPACITOR

<b>Capacitance Range</b>	1 pF to 2700 pF
<b>Quality Factor (Q)</b>	Greater than 10,000 (1.0 pF to 1000 pF) @ 1 MHz Greater than 10,000 (1100 pF to 2700 pF) @ 1 KHz
<b>Temperature Coefficient of Capacitance (T.C.)</b>	+90 ±30 PPM/°C (-55°C to +125°C)
<b>Insulation Resistance (IR)</b>	1 pF to 2700 pF 10 <sup>5</sup> Megohms min. @ +25°C at rated WVDC 10 <sup>4</sup> Megohms min. @ +125°C at rated WVDC  Max. test voltage is 500 VDC
<b>Working Voltage (WVDC)</b>	Up to 2500 WVDC. See Capacitance Values Table, See KYOCERA AVX 100C Series datasheet
<b>Dielectric Withstanding Voltage (DWV)</b>	See KYOCERA AVX 100C Series datasheet
<b>Retrace</b>	Less than ±(0.02% or 0.02 pF), whichever is greater

<b>Aging Effects</b>	None
<b>Piezoelectric Effects</b>	None (No capacitance variation with voltage or pressure)
<b>Capacitance Drift</b>	±(0.02% or 0.02 pF), whichever is greater Operating Temperature Range: From -55°C to +125°C (No derating of working voltage)

### 100 C SERIES PERFORMANCE DATA

**ESR VS CAPACITANCE  
SERIES 100, CASE C**

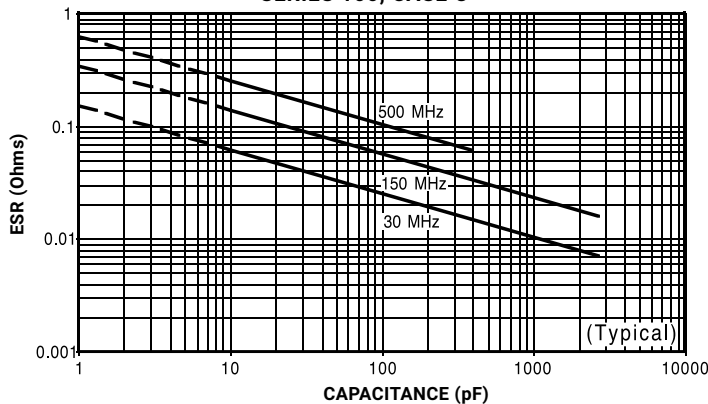

**CURRENT RATING VS CAPACITANCE  
SERIES 100, CASE C**

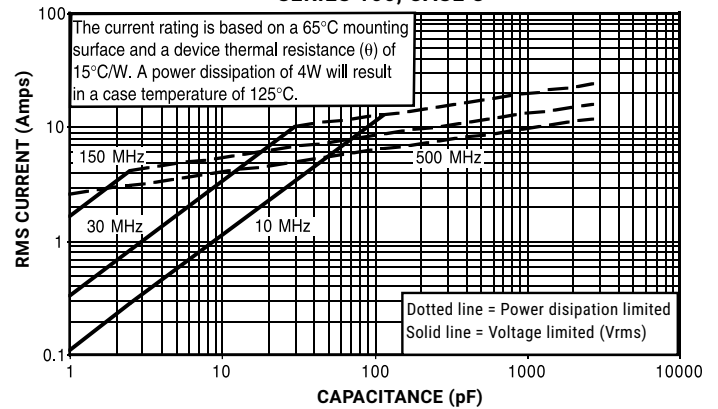



# Power Capacitor Assemblies

## Individual Capacitor Specifications for Power Capacitor Assemblies



### 100 E SERIES PORCELAIN HIGH RF POWER MULTILAYER CAPACITOR

<b>Capacitance Range</b>	1 pF to 5100 pF
<b>Quality Factor (Q)</b>	Greater than 10,000 (1 pF to 1000 pF) @ 1 MHz Greater than 10,000 (1100 pF to 5100 pF) @ 1 KHz
<b>Temperature Coefficient of Capacitance (T.C.)</b>	+90 ±30 PPM/°C (-55°C to +125°C)
<b>Insulation Resistance (IR)</b>	1 pF to 5100 pF: 10 <sup>5</sup> Megohms min. @ +25°C at 500 VDC 10 <sup>4</sup> Megohms min. @ +125°C at 500 VDC
<b>Working Voltage (WVDC)</b>	Up to 7200 WVDC See Capacitance Values Table, See KYOCERA AVX 100E Series datasheet
<b>Dielectric Withstanding Voltage (DWV)</b>	See KYOCERA AVX 100E Series datasheet
<b>Retrace</b>	Less than ±(0.02% or 0.02 pF), whichever is greater
<b>Aging Effects</b>	None

<b>Piezoelectric Effects</b>	None (No capacitance variation with voltage or pressure)
<b>Capacitance Drift</b>	±(0.02% or 0.02 pF), whichever is greater
<b>Operating Temperature Range</b>	From -55°C to +125°C (No derating of working voltage)

### 100 E SERIES PERFORMANCE DATA

**ESR VS CAPACITANCE  
SERIES 100, CASE E**

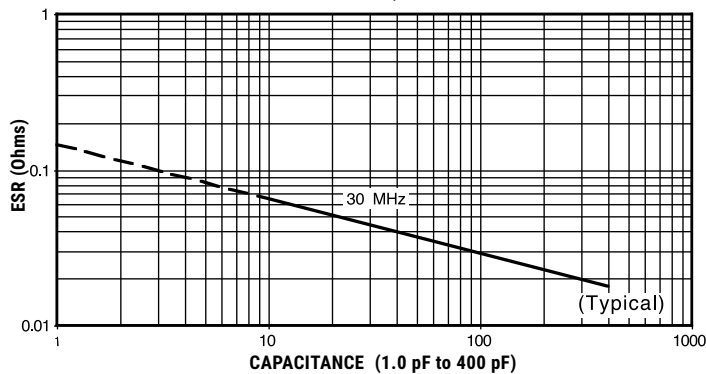

**ESR VS CAPACITANCE  
SERIES 100, CASE E**

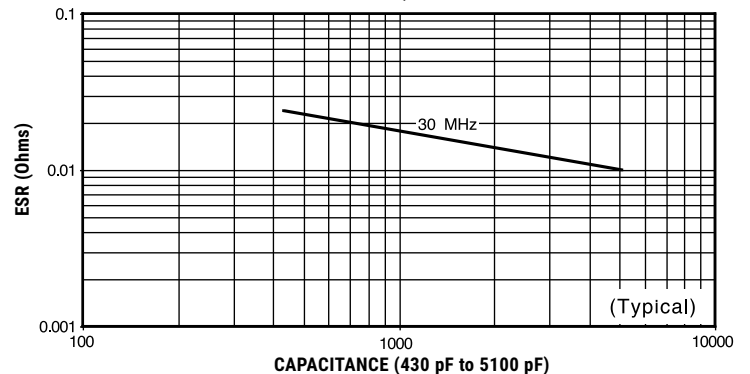

**CURRENT RATING VS CAPACITANCE  
SERIES 100, CASE E, EXTENDED VOLTAGE**

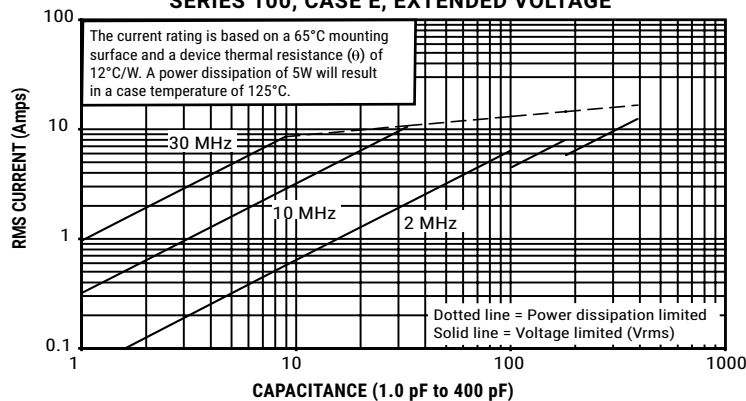

# Power Capacitor Assemblies

## Individual Capacitor Specifications for Power Capacitor Assemblies



### 900 C SERIES PORCELAIN HIGH RF POWER MULTILAYER CAPACITOR

<b>Capacitance Range</b>	0.01 $\mu$ F to 1 $\mu$ Fd
<b>Dissipation Factor (DF)</b>	2.5% max. at 1 KHz
<b>Temperature Coefficient of Capacitance (TCC)</b>	Less than 0 $\pm$ 15% (-55°C to +125°C)
<b>Insulation Resistance (IR)</b>	0.01 MFd to 1 MFd 1000 megohms min. @ +25°C at rated WVDC 100 megohms min. @ +125°C at rated WVDC
<b>Working Voltage (WVDC)</b>	Up to 300 WVDC See capacitance values in KYOCERA AVX 900 C Series Datasheet
<b>Dielectric Withstanding Voltage (DWV)</b>	KYOCERA AVX 900 C Series Datasheet
<b>Aging Effects</b>	3% maximum per decade hour
<b>Piezoelectric Effects</b>	Negligible
<b>Dielectric Absorption</b>	2% typical
<b>Operating Temperature Range</b>	-55°C to +125°C (No derating of working voltage)

### 900 C PERFORMANCE DATA

**ESR VS CAPACITANCE  
SERIES 900, CASE C**

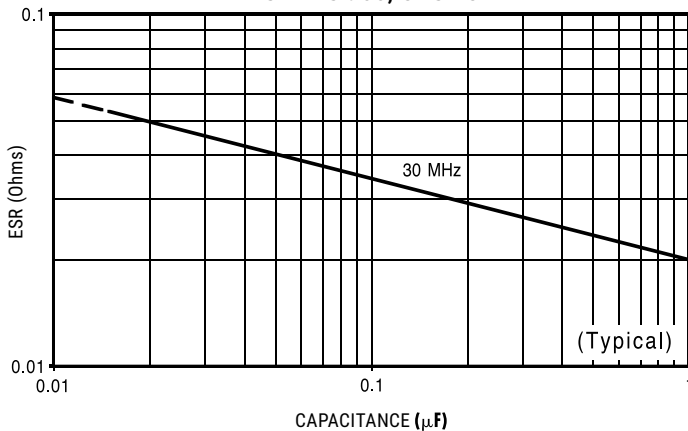

**CURRENT RATING VS CAPACITANCE  
SERIES 900, CASE C**

